

# **2015 OWNER'S MANUAL**

---



**320EC**



1090 WEST SAINT JAMES  
TARBORO, NORTH CAROLINA 27886  
PH.866/485-8899 ■ FAX 919/882-8035

---

Dear World Cat owner:

Thank you for being our customer. Welcome aboard!

We wish to take this opportunity to sincerely thank you for putting your trust in our boat building team and becoming the newest member of the World Cat Family.

The following manual is designed to ensure you enjoy your new World Cat for many years to come. We have made every effort to ensure you and your family are safe, enjoy the unique features of a World Cat, and continue to love the World Cat ride that no other boat company can offer.

If you should ever need assistance with the care, maintenance or operation of your boat, then please contact your dealer. If you have questions that your dealer cannot answer, please feel free to contact Phyllis Manning, our customer care manager at 866-485-8899 extension 206 at your convenience or e-mail her at [pmanning@worldcat.com](mailto:pmanning@worldcat.com).

Once again, thank you for becoming a part of our family.

Best Regards,

World Cat

Andrew Brown  
President  
[abrown@worldcat.com](mailto:abrown@worldcat.com)

Best Regards,

World Cat

Phyllis D. Manning  
Customer Care Manager  
866.485.8899 x 206  
[pmanning@worldcat.com](mailto:pmanning@worldcat.com)

Chapter 1: Customer Information .....	1-7
1.1 Owner’s Portfolio .....	1-7
1.2 Warranty Information .....	1-7
1.3 Dealer Responsibilities .....	1-7
1.4 Owner’s Responsibilities .....	1-8
1.5 Manual Legend .....	1-8
!!! DANGER .....	1-8
!!! WARNING .....	1-8
!!! CAUTION .....	1-8
NOTICE .....	1-8
Chapter 2: Boat Information .....	2-9
Chapter 3: Boat Specifications .....	3-10
3.1 320EC Standard Boat Specs .....	3-10
3.2 320EC Features .....	3-11
Chapter 4: Safety and Regulations .....	4-12
4.1 Operator Responsibilities .....	4-12
4.2 Registration .....	4-12
4.3 Coast Guard Required Safety Equipment .....	4-12
NOTICE .....	4-12
4.4 Recommended Safety Equipment .....	4-12
!!! CAUTION .....	4-13
4.4.1 Capacity Information .....	4-13
4.5 Pollution Regulations .....	4-13
4.5.1 Oil and Hazardous Substances .....	4-14
4.5.2 Disposal of Plastics/Dunnage/Garbage .....	4-14
4.6 Boating Safety Guidelines .....	4-14
4.6.1 Pre-Departure .....	4-14
4.6.2 Launching .....	4-14
4.6.3 Underway: (See Chapter 5 on Performance) .....	4-15
4.6.4 Returning .....	4-15
4.7 Trailering .....	4-15
4.8 Anchoring .....	4-16
!!! CAUTION .....	4-16
4.9 Shallow Water .....	4-16
4.10 Emergency Situations .....	4-16
4.10.1 Emergency Stop Switch .....	4-16
4.10.2 Communication .....	4-16
4.10.3 Rendering Assistance .....	4-16
4.10.4 Reporting Accidents .....	4-17
4.10.5 Weather .....	4-17
4.10.6 Towing .....	4-17
4.11 Carbon Monoxide (CO) .....	4-17
!!! DANGER .....	4-17
Chapter 5: Performance .....	5-18
5.1 Overview .....	5-18
5.2 Motor Trim .....	5-18
5.2.1 Bow Up Condition .....	5-18
5.2.2 Bow Down Condition .....	5-18
5.3 Engine Controls .....	5-19
5.4 Steering Controls .....	5-19
5.5 Steering Maintenance .....	5-19

!!! CAUTION.....	5-19
Power Steering System Diagram.....	5-20
5.6 Power Steering System- Bleeding Instructions .....	5-21
NOTICE.....	5-21
5.6.1 Step 1.....	5-21
5.6.2 Step 2.....	5-21
5.6.3 Step 3.....	5-21
5.6.4 Step 4.....	5-21
5.7 Handling Characteristics.....	5-21
5.7.1 Turning Characteristics .....	5-22
5.7.2 Adverse Sea Conditions .....	5-22
5.7.3 Cross-Clutching.....	5-22
5.7.4 Get the boat on plane.....	5-22
5.7.5 Keep the boat level (if the seas change or people move on the boat).....	5-22
5.7.6 Handling different sea conditions.....	5-23
5.7.7 Boating Tips.....	5-23
5.8 Performance Factors .....	5-23
5.8.1 Engine Efficiency.....	5-23
5.8.2 Propeller Condition .....	5-23
5.8.3 Weather Conditions.....	5-23
5.8.4 Load.....	5-24
5.8.5 Marine Growth .....	5-24
5.8.6 Bottom Paint.....	5-24
Chapter 6: Systems Information .....	6-25
6.1 Overview .....	6-25
6.2 Fueling Guidelines.....	6-25
!!! WARNING .....	6-25
!!! DANGER .....	6-25
!!! DANGER .....	6-25
6.2.1 Before Fueling.....	6-25
6.2.2 During Fueling .....	6-25
6.2.3 After Fueling .....	6-25
6.3 FUEL SYSTEM .....	6-26
6.3.1 Fuel System Benefits.....	6-26
6.3.2 Fuel Tank .....	6-26
6.3.3 Fuel Vent.....	6-26
6.3.4 Fuel Distribution System.....	6-26
6.3.5 Filling Fuel Tanks .....	6-27
!!! WARNING .....	6-27
!!! WARNING .....	6-27
6.3.6 Pressure Relief Fuel System Diagram.....	6-27
6.3.7 Trouble Shooting Tips.....	6-28
6.3.8 Integrated Fuel Demand Valve Components .....	6-29
6.4 Ethanol-blended fuel .....	6-29
NOTICE.....	6-29
6.4.1 Additives .....	6-29
6.5 Electrical System.....	6-29
6.6 Battery System.....	6-30
6.6.1 Battery Distribution.....	6-30
6.6.2 Voltage Sensor Relay (VSR).....	6-31
6.6.3 Emergency Parallel .....	6-31
6.6.4 24 Hour Circuits .....	6-31

---

NOTICE.....	6-31
6.6.5 Anchor Windlass .....	6-31
6.6.6 Windlass Deck Switch Maintenance.....	6-31
!!! DANGER .....	6-31
6.7 Battery Selection .....	6-32
6.8 Battery Care.....	6-33
!!! DANGER .....	6-33
6.8.1 Safety.....	6-33
6.8.2 Exposure.....	6-33
!!! CAUTION.....	6-33
!!! CAUTION.....	6-33
6.9 Wiring and Circuit Protection .....	6-33
6.10 Control System .....	6-34
!!! CAUTION.....	6-34
!!! CAUTION.....	6-34
6.11 Rocker Switch Diagram.....	6-35
6.12 Accessories .....	6-36
6.12.1 Navigational Lights .....	6-36
6.12.2 Cockpit Lights .....	6-36
6.12.3 Rigging Lights.....	6-36
6.12.4 Cabin / Console Lights .....	6-36
6.12.5 Spreader Lights (Standard on Hardtop).....	6-36
6.12.6 Dome Light (Standard on Hardtop).....	6-36
6.12.7 Bilge Pump / Float Switch .....	6-36
6.12.8 Raw Water Pump .....	6-36
6.12.9 Freshwater Pump.....	6-36
6.12.10 Livewell Pump.....	6-36
6.12.11 Macerator Pump.....	6-36
6.12.12 12v Outlets.....	6-36
6.12.13 Marine Head .....	6-36
6.12.14 Anchor Windlass - Freefall.....	6-37
6.12.15 Stereo (optional) .....	6-37
6.12.16 Windshield Wipers .....	6-37
6.12.17 Horn .....	6-37
6.12.18 ACC.....	6-37
6.12.19 Power steering .....	6-37
6.13 Gauge Packages.....	6-38
6.13.1 Yamaha™.....	6-38
6.13.2 Suzuki™.....	6-38
6.14 Plumbing System.....	6-38
Chapter 7: Maintenance and Service.....	7-39
7.1.1 Overview .....	7-39
7.1.2 Gelcoat Maintenance.....	7-39
7.1.3 Cleaning .....	7-39
!!! CAUTION.....	7-39
7.1.4 Waxing .....	7-39
!!! CAUTION.....	7-39
!!! CAUTION.....	7-40
!!! CAUTION.....	7-40
7.1.5 Repair .....	7-40
!!! WARNING .....	7-40
7.1.6 Bottom Paint.....	7-40

---

7.1.7	Upholstery .....	7-40
	!!! WARNING .....	7-40
7.1.8	Trim / Plexiglass / Polyethylene.....	7-40
7.1.9	Stainless / Aluminum .....	7-41
7.1.10	Bilge Compartments.....	7-41
7.1.11	Cockpit Drains.....	7-41
7.1.12	Winterization.....	7-41
7.2	Maintenance Schedule.....	7-43
7.3	Lewmar (Provided by Lewmar) .....	7-43
7.4	Maintenance Log .....	7-48
Chapter 8:	hurricane preparedness.....	8-49
Chapter 9:	2015 Warranty Policy .....	9-52
Chapter 10:	320EC Operation and Schematics .....	10-54
10.1	Operation of Standard Equipment .....	10-54
10.1.1	Battery Layout and Management .....	10-54
10.1.2	Bilge Pumps / Float Switches.....	10-55
10.1.3	Shower Sump .....	10-55
10.1.4	Freshwater System .....	10-55
	NOTICE.....	10-55
10.1.5	SEACOCKS.....	10-55
10.1.6	Livewell System.....	10-56
	NOTICE.....	10-56
	NOTICE.....	10-56
10.1.7	Raw Water System.....	10-56
10.1.8	Marine Head.....	10-57
1.1.1.1.	Initial Start Up.....	10-57
1.1.1.2.	Normal Use .....	10-58
	! CAUTION.....	10-58
	! CAUTION.....	10-58
1.1.1.3.	DECK PUMP-OUT .....	10-58
1.1.1.4.	Overboard Discharge .....	10-58
	! CAUTION.....	10-58
10.1.9	SHOREPOWER PACKAGE.....	10-58
1.1.1.5.	Connecting Shore Power.....	10-58
1.1.1.6.	DisConnecting Shore Power .....	10-59
10.1.10	AC Panel.....	10-59
10.1.11	Refrigerator.....	10-59
10.1.12	Microwave .....	10-59
10.1.13	Receptacles .....	10-59
10.1.14	Stove .....	10-59
10.1.15	Water Heater .....	10-59
	! CAUTION.....	10-60
10.1.16	Battery Charger.....	10-60
10.1.17	LCD TV.....	10-60
10.1.18	Anchor Windlass (Freefall) .....	10-60
	NOTICE.....	10-60
10.1.19	Windlass Deck Switch Maintenance .....	10-60
10.1.20	Teleflex™ Power Assist Unit .....	10-60
10.1.21	Generator .....	10-60
	! CAUTION.....	10-61
	! CAUTION.....	10-61
10.1.22	Climate Control Unit .....	10-61

10.2	Maximum Horsepower Rating: Twin 300 4-Stroke HP (600 HP total)	10-61
Chapter 11:	Operation of Optional Equipment	11-62
11.1.1	Stereo	11-62
11.1.2	Outriggers	11-62
11.2	System Diagrams	11-63
11.2.1	Access Plate and Rigging Tube Diagram	11-63
11.2.2	Hull Wiring Diagram	11-64
11.2.3	Forward Deck Wiring Diagram	11-65
11.2.4	Aft Deck Wiring Diagram	11-66
11.2.5	Cabin Wiring	11-67
11.2.6	Battery Management System Diagram	11-68
11.2.7	Freshwater System Diagram	11-69
11.2.8	Livewell / Raw-water System	11-70
11.2.9	Marine Head Diagram	11-71
11.2.10	Thru-hull Diagram	11-72
Chapter 12:	Spare Parts List for Non-Warranty Repairs	12-73

## Chapter 1: CUSTOMER INFORMATION

### 1.1 OWNER'S PORTFOLIO

To help you enjoy the many features, benefits, and accessories on your new World Cat, we have provided you with the following materials:

- World Cat Owner's Manual (model specific)
- Vendor Supplied Manuals for various accessories
- Delivery Checklist
- Warranty Information

We refer to this package as the "Owner's Portfolio", and will reference it often throughout this text. The portfolio contains a wealth of information, including advice on safety, operation, performance, maintenance, and warranty. Reading and maintaining this information is extremely important, and could be the difference between a positive and negative experience on the water.

For your convenience, World Cat also provides the NMMA text *Sportfish, Cruisers, Yachts Owner's Manual*. It will be referenced occasionally in your owner's manual, and provides supplemental information on safety and basic boating practices.

### 1.2 WARRANTY INFORMATION

Upon purchasing your new World Cat, the dealer is responsible for completing the warranty card provided by the factory. The Dealer is responsible for completing the warranty card and returning a copy to the factory. The Dealer should provide you with a copy to keep in a secure place so it can be referenced quickly in the event of a warranty issue. The 10 year limited hull warranty is transferable, and a copy is included at the back of this manual should you decide to sell your boat.

### 1.3 DEALER RESPONSIBILITIES

Our dealers are an extension of the factory, and we expect them to provide you with great customer service and help prepare you for a positive ownership experience. Therefore, we set forth a list of responsibilities for our dealers as follows:

- Provide courteous service and explanation of the product prior to the sale.
- Provide sea trials, if requested, for potential owners.
- Provide a detailed orientation of your boat's features and general operation upon delivery, including safety and performance.
- Complete and sign delivery checklist.
- Explain, complete, and submit all warranty information in a timely manner after the purchase.
- Provide the customer with the "Owner's Portfolio" and explain the information included therein.
- Provide service after the sale, or help the customer locate a qualified service at home or away.



## 1.4 OWNER'S RESPONSIBILITIES

As an owner you should also take an active part in the delivery and safe operation of your new catamaran. Some of your responsibilities are:

- Study and understand the limited warranty information.
- Read all literature in your "Owner's Portfolio" and operate the vessel in accordance with those instructions.
- Perform a walk through prior to the final delivery and ensure that the systems are functioning properly.
- Maintain the boat and perform service according to the instructions in this manual, including the 20 hour inspection for the vessel and engines.
- It is your responsibility to return your boat to an Authorized World Cat Dealer for warranty work.

Once your warranty information is processed, World Cat will maintain a record of your boat using the Hull Identification Number (HIN), which is located on the starboard side of the transom. Information regarding the dealership, owner, and the factory installed accessories will be recorded to help you should a problem arise. Also, you will receive an invitation to join Team World Cat and a survey to rate your purchasing experience and the initial impressions of our company. We ask that you join our family of owners and let us know your feelings about the purchase and the quality of our product.

## 1.5 MANUAL LEGEND

Throughout this manual you will encounter signals to alert of important information. Text printed in bold letters and the warning system shown below is of particular importance. Please review this information prior to reading the manual.

### ***!!! DANGER***

this symbol alerts you to hazards or unsafe practices which will cause extensive property damage, severe personal injury or death if the warning is ignored.

### ***!!! WARNING***

this symbol alerts you to hazards or unsafe practices which can cause extensive property damage, severe personal injury or death if the warning is ignored.

### ***!!! CAUTION***

this symbol alerts you to hazards or unsafe practices which can cause personal injury or property damage if the warning is ignored.

### **NOTICE**

this symbol is not hazard related. it contains information on installation, operation, or maintenance which is needed to ensure the proper operation of your boat.

## Chapter 2: BOAT INFORMATION

Please fill out the following information and leave in this manual for reference. This information will be important for our service personnel to provide fast and accurate service. (For service call 866-485-8899 or email [service@worldcat.com](mailto:service@worldcat.com).)

BOAT	
Model:	HIN:
Purchase date:	Delivery date:
Ignition Key #:	Door key #:
ENGINES	
Make:	Model:
Serial # Port:	Serial # Sbd:
Propeller Make/Model:	Propeller Diameter/Pitch:
TRAILER	
Make:	Model:
Serial # Port:	Serial # Sbd:
DEALER	
Name:	Salesman:
Dealer Phone:	Service Manager:

## Chapter 3: BOAT SPECIFICATIONS

### 3.1 320EC STANDARD BOAT SPECS



**World Cat**

**EC EXPRESS CABIN**



**320**

[www.worldcat.com/320ec](http://www.worldcat.com/320ec)

**SPECIFICATIONS**

LOA 32'2" | Beam 10'6" | Hull Draft 16" | Freeboard Aft 28" | Transom Height 25"  
Fuel Capacity 2 x 121 gal | Max HP Rating 2 x 300 hp | Approx. Dry Weight\* 11,400 lbs  
Trailer Height\*\* 11'2" | Bridge Clearance 9'8" | Cockpit Length 74"  
Freshwater Capacity 45 gal | Wastewater Capacity 10 gal  
Typical Cruise\*\*\* 26 mph / 1.6 mpg | Typical WOT\*\*\* 44 mph / 1.0 mpg

\* Includes max power and typical options  
\*\* Measured keel to top of fiberglass hardtop with no outriggers nor electronics installed (not including trailer height)  
\*\*\* Tested with max power, two people, 1/2 fuel, no gear



1090 West Saint James Street | Tarboro, North Carolina 27886 | [www.worldcat.com](http://www.worldcat.com) | 866.485.8899

### 3.2 320EC FEATURES



## 320EC FEATURES

#### STANDARD

##### Bow

- >> Molded-in bow pulpit with roller and cleats
- >> Pro series freefall windshield with 300' line, 15' chain, 22lb anchor, and foot switches at the deck
- >> Welded 316-grade stainless bow rail
- >> (2) 500-GPH forward bilge pumps with auto switches

##### Cabin

- >> Full cabin featuring master berth, aft quarter berth, galley and enclosed head
- >> Head area shower with sump pump, Vaco-Flush head with a 10-gallon holding tank and overboard discharge, integrated storage
- >> Galley Package with refrigerator, microwave, electric cooktop, and sink
- >> Cruise air® 12,000 BTU reverse cycle heating/cooling unit
- >> Shorepower connections with 30-Amp service, cordsets, AC panel with digital meter and battery charger
- >> LCD TV with DVD Player
- >> 45-gallon freshwater system w/ heater

##### Helm

- >> Fiberglass top with aluminum frame, moon roof, overhead lights, built-in speakers, (6) rocket launchers, and spreader lights
- >> Full wrap-around tempered safety glass windshield
- >> Panoramic-style heavy-duty windshield wiper with rinse
- >> Port and starboard bi-fold cabin entry doors
- >> Magnetic catches on cabin/head entry and walk-through doors
- >> Stainless steel wheel with power-knob
- >> Power-assisted hydraulic steering system

- >> Large electronics mounting area for (2) 12-inch screens
- >> Deluxe captain's chair helm with arm rests, flip-up bolster, flip-up foot rest. Three-way adjustable seat for maximum comfort at the helm
- >> Port and starboard L-shaped cushioned seats under enclosed hardtop with 90-quart insulated overboard draining cooler portside and access to generator starboard
- >> Fischer Panda® 4.3kW diesel generator with 10-gallon fuel tank
- >> Custom Strataglass curtain package
- >> 300-quart insulated centerline helm fishbox with overboard drain

##### Steer

- >> Expansive cockpit with horizontal rod storage and toe rails, fighting chair reinforcement plate, and tackle storage units
- >> Integrated cockpit step for easy in-and-out access (port and starboard)
- >> Raw water and freshwater stainless steel faucets under port and starboard gunwales
- >> (6) gunwale-mounted stainless steel rod holders
- >> Fold-down aft seating with cushions (port and starboard)
- >> (2) additional house batteries wired in parallel for increased reliability and longevity of the battery bank
- >> 40-gallon insulated livewell with 1100-GPH magnetic drive pump and overboard drain (port transom)
- >> Starboard bait prep station with sink, cutting board, and raw water faucet
- >> Freshwater washdown and cockpit shower
- >> Extended swim platform with integrated handrails and ladder

#### OPTIONAL

##### Electronics

- >> Marine stereo system with (4) speakers and iPod/MP3 port
- >> Conversion kit to 220/240v power
- >> 4-Stroke Engine Packages with engines, rigging, controls and props
- >> Suzuki 300 hp
- >> Yamaha 300 hp
- >> Yamaha Helm Master Joystick Control

##### Livewell

- >> Additional 40-gallon re-circulating livewell with pump and overboard drain (replaces starboard bait-prep station on the transom)

##### Outriggers

- >> Rupp custom sidemount outriggers with 15' fixed poles
- >> Taco 370 Grand Slam(tm) outriggers with 18' telescopic poles

##### Top

- >> Upper station Station Yamaha Helm Master Controls, bimini, rocket launchers, and center rigger
- >> Second Station Helm Master controls
- >> Matching hardtop underside to hull side color



World Cat strives to offer the best quality & safest boats on the water. As a result, World Cat reserves the right to make changes in specifications, options, standard features, and discontinue models at anytime without notice or obligation. Weight and dimensions of all models are approximate. Please contact your local dealer or the factory for additional information.



---

## Chapter 4: SAFETY AND REGULATIONS

### 4.1 OPERATOR RESPONSIBILITIES

Prior to enjoying your World Cat, it is important to read and understand all the information detailed in your “Owner’s Portfolio”. Knowing how to operate and maintain the systems on your vessel can make your experiences safe and enjoyable, as well as increase the performance and longevity of your boat. Federal law and most state laws clearly indicate that it is the operator’s responsibility to maintain their vessel, and to operate it in a manner which protects the safety of their passengers and others. Reference page 10 of the *Sportfish, Cruisers, Yachts Owner’s Manual* for a detailed list of owner responsibilities.

This manual will provide you a basic understanding of boating practices; however, we recommend all owners review federal, state, and local regulations regarding safety and traffic prior to using your World Cat. The U.S. Coast Guard Auxiliary and U.S. Power Squadrons offer excellent educational opportunities on a local level and are open to anyone. If a chapter does not exist in your area, reference page 10 of the *Sportfish, Cruisers, Yachts Owner’s Manual* or contact the following numbers for other educational opportunities:

Boating Education Hotline                      1-800-336-BOAT (2628)  
U.S. Coast Guard Boating Hotline            1-800-368-5647

### 4.2 REGISTRATION

Vessels are required by federal and state law to be registered in the state where they are primarily used. Registration numbers and validation stickers must be displayed per regulations, and a certificate of registration must be on board while the vessel is being operated. When traveling away from your home waters, contact authorities at your destination to determine if any additional registration is required. Some areas require permits or temporary registrations to operate in their waters. When completing registration forms you will be asked for the Hull Identification Number (HIN). On your World Cat, the HIN is located on the starboard side of the transom. This number is unique to your boat and will be important for registering your vessel, as well as, communicating with your dealer and our service department. Including this information in any correspondence or conversations will help our support network serve you better.

### 4.3 COAST GUARD REQUIRED SAFETY EQUIPMENT

Once you have reviewed safe boating guidelines and filed for registration, it is time to equip your vessel. The U.S. Coast Guard’s (U.S.C.G.) list of required equipment is shown below. To review the guidelines for each item, reference pages 23 and 24 of the *Sportfish, Cruisers, Yachts Owner’s Manual*.

- Audible Signaling Device (Bell, Horn, or Whistle)
- Fire Extinguisher
- Navigation / Anchor Lights
- Flotation Devices (PFD’s)
- Visual Signaling Devices

NOTICE
Remember to check with state and local agencies to ensure that additional items are not required to operate your boat in their waterways.

### 4.4 RECOMMENDED SAFETY EQUIPMENT

Although not required, there are several additional items which help to ensure safety, and provide convenience for you and passengers. A list of these items can be found in the *Sportfish, Cruisers, Yachts Owner’s Manual* on page 24. Perform an annual inventory to keep tools, spare parts, and safety equipment in good condition. Immediately replace

any items that have been removed from the kit.

**!!! CAUTION**

Use only marine grade replacement parts. Most automotive and residential parts are not suitable for use in the harsh marine environment. Using them could lead to premature product failure, property damage, or personal injury.

#### 4.4.1 Capacity Information

On all boats under 26 feet in length, the manufacturer is required to provide capacity information. If you own a model under 26 feet in length you will find a rectangular metal plate near the helm. This plate will provide information on horsepower ratings and total capacities which include person capacities, motor(s) and gear. As an owner you should be aware of the weight on board. Exceeding capacity can endanger your passengers and vessel, as well as void any warranty remaining on the boat should a failure occur. Remember this is a guideline for normal operation, and does not release you from responsibility should an accident occur. You must use rational judgement when adverse conditions are expected, and reduce your loads to create a margin of safety.



This label means your World Cat is certified by the NMMA. With this tag, you are assured your fuel system, electrical system, lighting, ventilation, and steering are not only in compliance with the US Coast Guard regulations, but also meet the more stringent standards of the NMMA. The NMMA is a national trade organization serving all elements of the recreational boating industry including manufacturers of boating equipment. With this tag, you can have confidence in the safety of your boat.

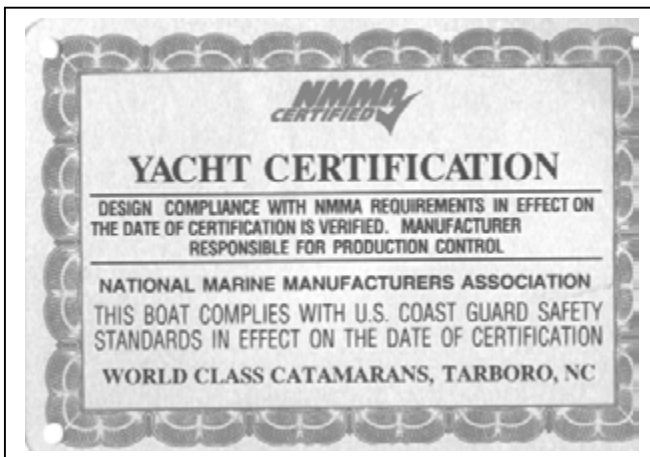

Pursuant to NMMA certification, all World Cats over 26' in length are "Yacht Certified" and carry the placard shown below. Person and gear capacities are not predetermined, they are left to the operator's discretion. Therefore, the amount of load allowed onboard should result from considering all safety precautions.

Horsepower ratings, however, are set by World Cats and should not be exceeded. The second page in Section 9.2 of this manual will provide information on the maximum horsepower ratings for your boat. Exceeding the factory recommendation will result in loss of warranty coverage on your vessel.

## 4.5 POLLUTION REGULATIONS

The Refuse Act of 1899 prohibits throwing, discharging or depositing any refuse matter of any kind (including trash, garbage, oil and other liquid pollutants) into the waters of the United States. This information is provided in a pamphlet, that normally received when registering your boat. Use the information below as a guideline, but study the pamphlet and understand any local regulations regarding pollution control. As the operator, you are also liable for individuals on your vessel disposing of materials in an improper manner.

#### 4.5.1 Oil and Hazardous Substances

The Federal Water Pollution Control Act prohibits the discharge of oil or hazardous substances which may be harmful into U.S. navigable water. Vessels 26 feet in length and over must display a placard at least 5 by 8 inches, made of durable material. The placard must be installed in a conspicuous place in the rigging compartments or near the bilge pumps and state the following:

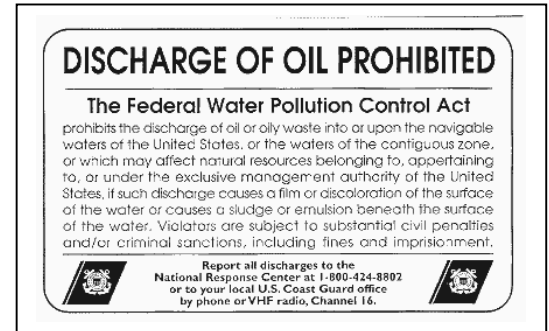

#### 4.5.2 Disposal of Plastics/Dunnage/Garbage

Boats 26 feet in length and over must display a Save Our Seas Placard which outlines the rules for dumping waste offshore. The placards must be at least 4" x 9" and should be displayed in an area visible during normal operation. They can be purchased from your dealer or marine equipment suppliers.



### 4.6 BOATING SAFETY GUIDELINES

As an owner/operator you should be prepared to handle any situation which arises before departure, while underway, or upon return to dock. Careful planning will add safety and pleasure to your experience and give you the confidence to handle emergencies if they develop. Listed below are some general guidelines which you should follow before any trip:

#### 4.6.1 Pre-Departure

- Establish a float plan and provide it to a person whom you trust. The plan should give the details of your trip, including where you are going and when you expect to return. If you deviate from the plan, notify that person as soon as possible.
- If you anticipate operating in a new area, understand the local rules and request charts or information on any hazards you may not be aware of.
- If you are towing the boat, inspect the trailer including tires, lights, brakes, winch, and overall mechanical appearance. *Sportfish, Cruisers, Yachts Owner's Manual page 105.*
- Verify that you have all necessary safety equipment. This should include all the USCG required equipment as well as spare parts or other items you decided to include.
- Check fuel levels and determine if you require additional fuel for your trip.
- Examine the weight of the gear on your vessel and make sure you are not overloaded. Distribute the weight evenly on your vessel to ensure predictable performance.

#### 4.6.2 Launching

- Prepare your boat prior to backing down, (i.e. secure all loose items, install garboard drain), then launch your vessel and move away quickly.
- Move your vessel away from the dock and complete a full system check. Ensure that electronics, pumps, and safety equipment are in working order.
- Instruct a passenger on the operation of the boat, and the location and function of all safety equipment onboard. You should never be the only person capable of safely operating your vessel.

#### 4.6.3 Underway: (See Chapter 5 on Performance)

- Obey all “Rules of the Road” and any local regulations. Use the information located on page 13 of the *Sportfish, Cruisers, Yachts Owner’s Manual* to understand right of way and the various navigational and hazard indicators you will see on the water.
- **Never operate a boat under the influence of alcohol or drugs.**
- Do not allow individuals under the age of 16 to operate the vessel. Maintain direct supervision of inexperienced operators.
- Ensure that all passengers are safely seated while underway, and are using the hand rails World Cat has provided to remain securely in their seats.
- Use your electronics and judgement to remain abreast of changing weather. Storms develop quickly and you should be prepared to protect your passengers and vessel. See page 22 of the *Sportfish, Cruisers, Yachts Owner’s Manual* for more tips on weather.
- Maintain a safe speed and respect other boaters as well as those on land. Obey all “No Wake Zones” and be aware of smaller vessels. The wake you produce could endanger other crafts and their passengers.
- Know the limitations of your craft and your experience. Understand the boats handling characteristics and do not attempt to operate the vessel in conditions that are unsafe or beyond your experience level.

#### 4.6.4 Returning

- Obey navigational markers and be aware of any tidal changes since departure.
- Collect and dispose of refuse properly to maintain our waters for future generations.
- Prepare your boat for loading before moving to the dock. Quickly pull your vessel from the water and move away from the ramp to complete the preparation for trailering.
- Verify that trailer systems are working properly and all items are secured before leaving.
- Wash the boat and perform general maintenance, upon returning home. (See instructions in Chapter 5).

As stated above, these are only general guidelines for safe boating. We recommend using these and any other available resources to protect your passengers as well as your vessel. Checklists can be an important tool in accomplishing this, see the example on pages 44 & 45 of the *Sportfish, Cruisers, Yachts Owner’s Manual*.

### 4.7 TRAILERING

Due to the nature of the hull, catamarans require specialized trailers. Your dealer will be able to provide them, as well as, information on safe trailering practices. Tow vehicles should be rated to handle the load and stresses which accompany trailering your boat. A properly matched trailer should carry 5-10% of the total vessel weight on the tongue. Routine inspections should be performed on the vehicle and trailer prior to each trip, and thorough checks scheduled on an annual basis.



## 4.8 ANCHORING

World Cat supplies an anchor and anchor windlass as standard equipment on your 320EC. The anchor we supply is known as a plow style. However, there are several types of anchors available, each designed to operate in specific bottom conditions. Your dealer can provide information on which styles are most effective in your area. See page 56 of the *Sportfish, Cruisers, Yachts Owner's Manual* for more information and tips concerning anchoring.

### **!!! CAUTION**

Never anchor your boat off the stern. The weight at the transom, combined with adverse sea conditions could allow water to enter the boat over the transom wall.

## 4.9 SHALLOW WATER

Although your World Cat draws a small amount of water for its size, shallow water should be a concern of all boaters. To avoid this hazard, pay particular attention to navigational markers and know the area you are operating in. Be aware of tidal changes, including those that have occurred during your trip. Rocks, stumps, or other hazards are more prevalent in shallow water and can cause major damage to your hull bottom. Engines can also suffer damage if they are allowed to run in the sand or mud.

If you do become grounded, tilt the motors up to reduce the draft at the transom. Often this will solve the problem; however, it may be necessary to rock the boat from side to side to break the suction along the keel. If you are grounded on an incoming tide, allowing the water to rise can help. Being grounded on an outgoing tide is a larger issue, you need to act quickly to free your boat and avoid being driven further aground. Use the anchor to secure the boat and await the incoming tide, or use it to pull yourself free.

## 4.10 EMERGENCY SITUATIONS

Unfortunately, even the safest boating practices cannot eliminate the potential of emergency situations developing. Therefore you should prepare yourself, and your crew, to handle any problems that may arise. Establish specific plans for fires, man overboard, collision, etc., and review them with your passengers prior to departing. Planning allows people to remain calm, and gives everyone the confidence to resolve the problem. Section 4 of the *Sportfish, Cruisers, Yachts Owner's Manual* provides information on emergency procedures. Below is important information which all owners should be aware.

### 4.10.1 Emergency Stop Switch

Lanyard clips are provided on all World Cats and when used properly provide an emergency stop for the engines should the driver fall from the helm position, or need to perform an emergency shutdown to respond to or avoid an accident. The clip attaches the driver to the ignition panel using a cord. A pull on the cord will release the clip from the shut-off switch on the panel and shutdown the engines. To restart the engines, turn ignition switches to the off position, return binnacle to neutral position insert safety lanyard back into clip and then turn ignition switches back on. This should only be used to prevent or react to accidents, and the operator is solely responsible for the decision.

### 4.10.2 Communication

If you witness an emergency or become involved in one, you should request assistance via radio communication or visual signals. Review the information in Section 4 of the *Sportfish, Cruisers, Yachts Owner's Manual* for detailed information on how and when to request assistance.

### 4.10.3 Rendering Assistance

Owners are required by law to render assistance to other boaters involved in an emergency situation such as fire, collision, casualty, etc., as long as it does not endanger your vessel or its passengers.

#### 4.10.4 Reporting Accidents

Federal regulations require that operators involved in an accident file a written account of the situation within 48 hours. Reports should be submitted to the State Boating Law Administrator. You can obtain forms through the USCG or local authorities (i.e. harbor patrol, sheriff or police offices). In the event that a casualty or disappearance occurs as the result of an accident, you must notify the authorities immediately by phone or radio and fill out a written statement.

#### 4.10.5 Weather

Pay attention to weather patterns. If you find yourself in the path of a storm, seek shelter immediately. If you cannot reach a dock, seek refuge inside the boat while the storm advances. Never get in the water, and stay clear of metal components on your boat. If lightning strikes, it would likely pass through metal objects seeking a ground.

#### 4.10.6 Towing

Due to an accident or loss of power, it may become necessary to tow another vessel or have your boat towed. If you are providing assistance, never attempt to tow a boat larger than your own. Be certain to use proper lines (ropes) and rational judgement to prevent further damage. Tow lines are under heavy strain, therefore passengers should remain clear of the lines to protect themselves from injury. For more information on towing, reference page 39 of the *Sportfish, Cruisers, Yachts Owner's Manual*.

### 4.11 CARBON MONOXIDE (CO)

#### **!!! DANGER**

Carbon Monoxide (CO) is a colorless, odorless, and tasteless gas produced by the exhaust system of any combustible engine. CO can cause brain damage or death, if inhaled over an extended period of time. To protect yourself and your passengers, never block the ventilation outlets in cabins, consoles, or other enclosed spaces.

One of the most important considerations when dealing with boating safety is carbon monoxide. Commonly referred to as (CO), carbon monoxide is a colorless, odorless, and tasteless gas emitted from any engine exhaust. Including inboards and outboards. A CO particle is close in weight to the air we consume; therefore it does not rise or fall in the atmosphere, but accumulates in enclosed spaces. Boat owners with enclosed heads, cabins, or canvas enclosures should pay particular attention to CO. Be aware that fumes produced on your boat can affect other vessels and other boats can affect you. A primary concern is the use of generators when boats are moored adjacent to each other.

Carbon Monoxide is poisonous and potentially fatal if inhaled over an extended period of time. Symptoms of CO poisoning include:

- Dizziness
- Nausea / Vomiting
- Headache / Throbbing in the temples
- Fatigue
- Muscular twitching
- Inability to focus or think clearly

If you or any of passengers experience any of these symptoms, leave the area and find a source of fresh air immediately. If your symptoms persist, seek medical attention.

## Chapter 5: PERFORMANCE

### 5.1 OVERVIEW

This chapter will provide information on the performance characteristics of your catamaran; This is not a substitute for seamanship training or hands-on experience. First time boat owners should use the resources detailed in Chapter 1 to learn proper methods of boat operation. Experienced boaters who have never owned a catamaran, should study this chapter completely. Do not assume that previous boating experience will apply to all situations, as there are several subtle differences in the handling characteristics of twin hulled boats. For existing catamaran owners, this chapter should be a reference.

### 5.2 MOTOR TRIM

The smooth riding characteristics of a catamaran are a result of the twin hull design. Their ability to slice through oncoming waves is far superior to the slamming characteristics seen on conventional vessels. Motor trim plays an integral part in how your catamaran accomplishes this. In a level or bow down attitude, your boat will slice through larger chop but you may experience sluggish performance, a wetter ride and increased bow steering in a following sea. In a bow up attitude the boat will perform better, but may ride less smoothly. Experiment with the trim settings in various sea conditions to determine what you are most comfortable with. When using the trim to correct a listing condition, imagine an “X” connecting the starboard engine to the port bow, and port engine to the starboard bow (see drawing below).

#### 5.2.1 Bow Up Condition

To correct a bow up condition on the port sponson, adjust the motor trim “down” on the starboard engine. This will help the starboard sponson to rise and level the vessel. If moving to the lowest trim setting on the starboard engine does not correct the list, trim the port engine “up” to assist the change. Reverse the instructions to accommodate for a bow up condition on the starboard sponson.

#### 5.2.2 Bow Down Condition

To correct a bow down condition on the port sponson, adjust the motor trim “up” on the starboard engine. This will help the starboard sponson to fall and level the vessel. If cavitation occurs on the starboard engine, lower it to correct the problem, then trim the port engine “down” to assist the change. Reverse the instructions to accommodate for a bow down condition on the starboard sponson.

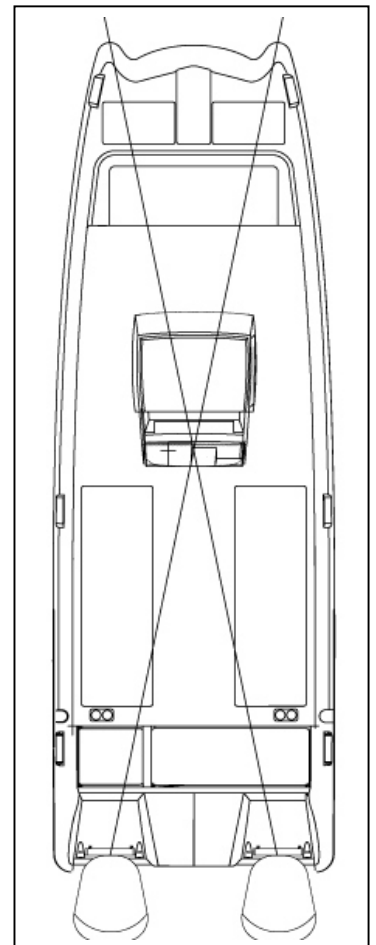

### 5.3 ENGINE CONTROLS

All factory rigged boats will come equipped with a binnacle control specific to your type of engine. Located at the helm, the binnacle controls the throttle, shift, and trim mechanisms for your engine. For diagrams and general information about this system, review pages 80 thru 83 of the *Sportfish, Cruisers, Yachts Owner's Manual*. Also read the owner's manual provided by your engine manufacturer to determine how to operate the features on your binnacle. If any components of this system need to be replaced, be certain to use the same style and length as the original equipment.

### 5.4 STEERING CONTROLS

Catamarans offer unsurpassed steering control. The wide spacing of the engines, advanced steering components, and handling characteristics of the World Cat hull give operators exceptional maneuverability in even the tightest spaces.

Because of the superior tracking abilities of the World Cat hull, oversteering can present a problem, especially for owners accustomed to operating conventional boats. Conventional vessels have a tendency to lose tracking abilities in rough and following sea conditions, making constant course corrections necessary. However, catamarans do not exhibit those traits and require operators to take a "hands off" approach. To do so, relax your grip and fight the urge to make constant corrections.

### 5.5 STEERING MAINTENANCE

The design of a catamaran hull requires a special steering system which features a "liquid tie-bar", as opposed to the mechanical version used in conventional boats. For this reason, all World Cats are equipped with a hydraulic steering system, featuring steering cylinders mounted on each engine and a steering system valve. This system enables both engines to respond in unison to adjustments at the helm.

In order to maintain the excellent steering characteristics of your boat, occasionally you will need to adjust the steering system to realign the motors (known as motor toe). To do so follow these instructions:

Using the helm, center the starboard motor.

Find the steering system valve, located under the inspection port on the center of the transom.

Open the valve by rotating it 90 degrees (the handle will be parallel to the valve body when open). This will isolate the port engine, so that it can be adjusted manually.

Center the port motor manually; then close the steering system ball valve and reinstall the inspection port.

Similar to hydraulic braking systems in an automobile, it may become necessary to bleed the steering system occasionally to remove air from the lines. We have provided diagrams of the steering system in section 5.6 thru 5.9, and the Teleflex™ owner's manual in your "Owner's Portfolio". Use the resources, and your dealer, to keep the steering system in excellent working order. Be aware, these are routine maintenance procedures and are not covered under warranty by World Cat.

<b>!!! CAUTION</b>
Routinely check hydraulic fluid levels, and all connections for leaks or any sign of mechanical failure. Lubricate all mechanical parts at least annually with high quality marine grease. Failure to do so may result in impaired or unresponsive steering.

**POWER STEERING SYSTEM DIAGRAM**

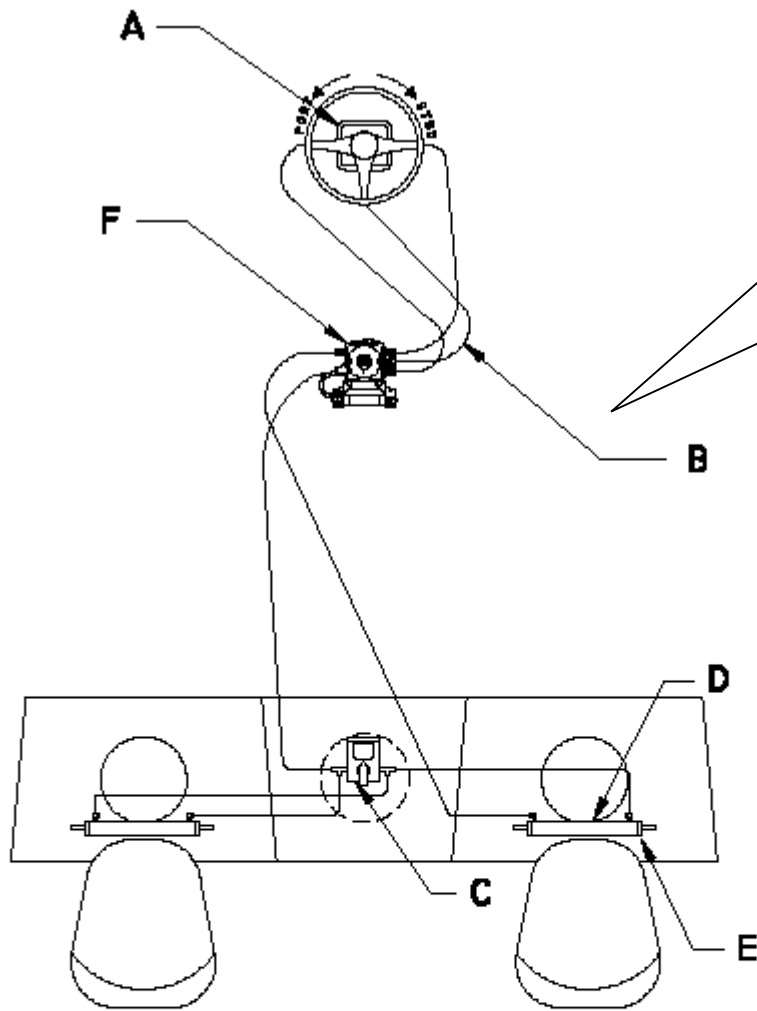

<u>ITEM</u>	<u>DESCRIPTION</u>	<u>QUANTITY</u>
A	SEA STAR II HELM	1
B	KEYLAR STEERING HOSE	2
C	STEERING SYSTEM VALVE	1
D	KEYLAR PIGTAIL 4'-6'	3
E	STEERING CYLINDERS	2
F	TELEFLEX POWER STEERING PUMP	1

## 5.6 POWER STEERING SYSTEM- BLEEDING INSTRUCTIONS

Reference the bleeding instructions provided by the Teleflex™ owner's manual, which is included in your "Owner's Portfolio". Use them in conjunction with the instructions and diagram below to bleed the steering system. This should be done annually.

### NOTICE

If possible, have your dealer or trained marine technician perform routine maintenance or repairs on your steering system. Replace faulty parts immediately.

#### 5.6.1 Step 1

- With the Power Purge turned "OFF", attach helm fitting and leads.
- Attach one of the leads to the bleader valve on the Power Assist Pump.
- Open the bleader valve using a 5/8" wrench.
- Turn the Power Purge unit "ON".
- Watch for air bubbles in the clear hydraulic lines. Once no more bubbles can be seen and there is a steady flow of hydraulic fluid through the lines, allow the Power Purge to run for an additional 60 seconds.
- The helm is now full of fluid. Turn Power Purge "OFF". Close bleader valve and disconnect line from the Power Assist Pump. Place dust cap back on bleader valve.

#### 5.6.2 Step 2

- Attach the four lines to each of the bleeder valves on the steering cylinders.
- Open each of the four bleeder valves.
- Turn Power Purge "ON".
- Turn the steering wheel slowly 20 times clockwise, then slowly 20 times counter-clockwise.

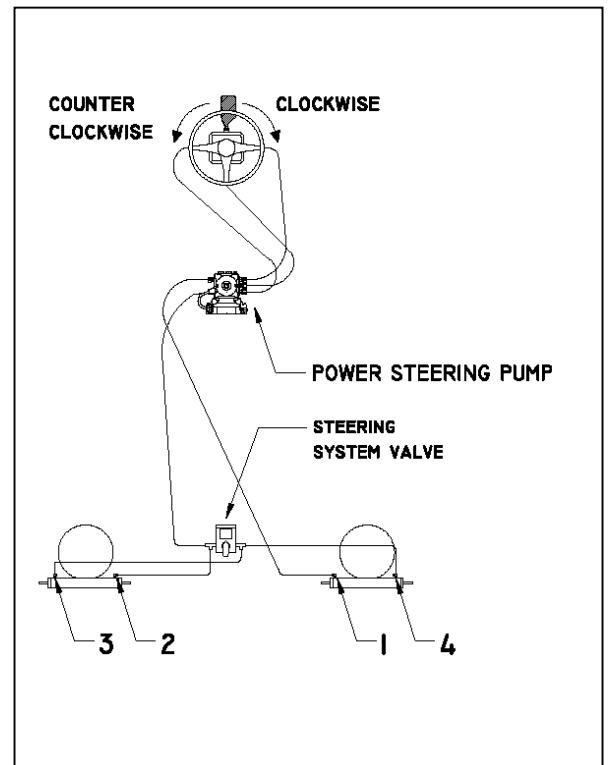

#### 5.6.3 Step 3

- With Power Purge turned "ON", move both engines through their full range of motion (This will help remove any air bubbles still trapped inside the cylinders).
- As a final precautionary step, pull on the engines firmly at the ends of their normal range of motion (This will also help to insure all of the air is out of the cylinders).

#### 5.6.4 Step 4

- Turn the ignition key for the port engine "ON". This will turn the Power Assist Pump "ON".
- Repeat "Step 2".
- If no more bubbles can be seen then the bleeding is complete. Turn the Power Purge "OFF". Close all four bleeder valves. Disconnect the four lines from the cylinders and both lines from the helm. Remove the helm fitting and replace it with vent cap.
- If bubbles are still present in lines, then bleeding was not successful. Repeat entire process.

## 5.7 HANDLING CHARACTERISTICS

World Cat's patented Vectroflo™ hull is a semi-displacement hull, which exhibits characteristics of both planing and

displacement hulls. Planing hulls provide speed and economy of operation since a limited amount of the hull is in contact with the water. However, they feature flat sections along the chine which can result in poor handling at low speeds and harder impacts at high speed. Displacement hulls provide superior handling characteristics, even at low speed, and an improved ride in rough water. Speed and economy suffer however, since more of the hull is submerged. World Cat has taken the best characteristics of these two designs and incorporated them in the Vectroflo™ hull. Our proven design provides a superior ride, excellent handling characteristics in a variety of conditions, and speed with economy of operation. To help you experience “The Ultimate Ride”, study the following sections.

### 5.7.1 Turning Characteristics

Turning a catamaran is slightly different than cornering on a conventional vessel. Imagine the difference between an automobile and a motorcycle. Automobiles take turns in a flatter, more stable, manner similar to catamarans hulls, while motorcycles pitch hard into a turn similar to a monohull. Do not underestimate a catamaran’s cornering ability however, hard adjustments to the steering wheel can make a World Cat bite quickly and execute high performance turns. Experiment with the handling ability of your cat so you are prepared for any situation on the water.

### 5.7.2 Adverse Sea Conditions

Catamarans are designed to handle some of the roughest waters in the world, but that is no substitute for common sense. As an operator you are responsible for the safety of your passengers and vessel; therefore, your trips should be limited by your level of experience. Planning and paying constant attention to the weather and sea conditions is paramount. If you are forced to operate in dangerous seas however, you can be confident that your World Cat, when operated properly, can handle them safely. Following are some tips on how to handle your boat in adverse sea conditions:

When traveling into the wind, changing your direction a few degrees to allow one sponson to settle before the other, can make the ride smoother and allow for increased speed.

In a rough chop with short wave intervals, increasing your speed may allow the boat to skim across the tops of each wave. This will result in a smoother ride.

Steer to avoid larger swells and breaking waves.

In a following sea, position your vessel on the back of a wave and match its speed to remain ahead of the trough. Speed is paramount. Work the throttle to avoid going over the wave or being thrown down the face of a following wave.

### 5.7.3 Cross-Clutching

- World Cat’s have their twin engines mounted 79 inches apart.
- This allows you to cross-clutch (one motor in forward while one in reverse)
- To dock, reverse the boat into a slip: put the outside motor in reverse and turn to face aft. Keeping the wheel straight, steer with the inside motor putting it in forward and reverse to guide you into the slip.
- Keep it simple and slow

### 5.7.4 Get the boat on plane

- Trim both engines down or in (the motors act as trim tabs forcing the bow down)
- Big advantage operating in shallow water (12” to 16” depending on the model)
- Quickly increase speed to get the boat on plane then slow down to 3500 RPM’s
- Adjust trim out until the motors cavitate then tap trim in
- Feel/hear the motors and do not watch the trim gauges
- A smooth ride is more important than having your engine RPM’s synchronized

### 5.7.5 Keep the boat level (if the seas change or people move on the boat)

- Trim the **High-Side-High**. When one side of the bow is high compared to the horizon, simply trim the high side motor up or out. (If it cavitates then trim the **low-side-low**)
- Different models have different sensitivity to trim (do not over-correct as this may cause the boat to pitch in flat calm water at high speeds)

### 5.7.6 Handling different sea conditions

**Head sea:** trim motors in to keep the bow down

**Following sea:** trim out to keep the bow out of the water

**Calm water:** trim engines up to run on the back of the hull

### 5.7.7 Boating Tips

Experience is the best way to determine the handling characteristics of your catamaran. Operating the boat in multiple sea conditions and under various loads will help you predict how the boat will perform in any situation. World Cat provides the following recommendations regarding the performance of your catamaran:

- Establish an RPM chart which details the speed and fuel consumption at various RPM levels to achieve the most economical operation.
- Monitor fuel gauges to determine the amount of operating time remaining at a given reading.
- Determine minimum speed for effective steering in close quarters.
- Determine the turning radius required at various speeds.
- Determine the rates of acceleration and deceleration with various load conditions. Include the distance required to stop the boat at various speeds.

Use the information provided in section 6 of the *Sportfish, Cruisers, Yachts Owner's Manual* for more information on boat handling.

## 5.8 PERFORMANCE FACTORS

Proper setup and maintenance of the systems on your boat is important to ensuring proper performance, but be aware they are not the only factors which affect it. Several things which contribute to the level of performance of your catamaran can change between or during trips.

### 5.8.1 Engine Efficiency

Without proper maintenance, your engine(s) will gradually lose power, resulting in a loss of speed. Use the recommendations in the engine's owners manual to schedule routine maintenance procedures and as a guide for the correct RPM range for your engines. Neglecting to do so may result in loss of performance and an increased risk of failure.

### 5.8.2 Propeller Condition

The size and condition of your prop also plays a major role in the performance of your catamaran. A damaged prop can result in lower speeds, sudden drops in RPM, increased fuel consumption, and severe vibration while running. Improperly sized props can cause damage to your engine as a result of exceeding the maximum or minimum RPM levels.

### 5.8.3 Weather Conditions

Barometric pressure and humidity can affect the output of your engines. For example, on an extremely hot and humid



day, your engine can experience as much as a 10 percent loss in horsepower. Although you should monitor your engines' performance, be aware that the weather could be a major factor in your boats performance.

#### 5.8.4 Load

Increased load can obviously affect performance, especially if the load is unbalanced. Passengers, gear, and fuel are all examples of things which can affect your vessel. Fuel levels change through the day, and greatly affect the attitude of your boat. When necessary, make adjustments to engine trim and load distribution to compensate for fuel usage.

#### 5.8.5 Marine Growth

If you store your boat in the water or fail to clean it after each trip, the existence of marine growth can contribute to a loss of performance. A decline in speed or increased fuel consumption can occur. Prevent this by applying a marine growth inhibitor or by cleaning your boat thoroughly after each trip.

#### 5.8.6 Bottom Paint

Bottom painting your catamaran will also change the performance. Although not significant, you can expect a drop in speed between 1 and 5 miles per hour.

## Chapter 6: SYSTEMS INFORMATION

### 6.1 OVERVIEW

This chapter will provide you with basic information for all the systems on your boat. Understanding this information is imperative, as it directly contributes to the safety and enjoyment of your trips on the water. If you need further information on any of these systems talk with your dealer.

### 6.2 FUELING GUIDELINES

Study the following guidelines thoroughly, and consult your dealer if you have questions. Be sure to read the engine manufacturers recommendations regarding the type and grade of fuel to use for your engines. If you are using a 2 stroke outboard engine, be sure to fill the oil tanks with manufacturer approved oil during each fill-up.

#### **!!! WARNING**

Avoid methanol or other alcohol based fuels or additives which can deteriorate fuel hoses, Alcohol based fuels also absorb water which can lead to engine damage.

#### **!!! DANGER**

Follow all safety guidelines while fueling. Leaking or spilled fuel is an explosion hazard. Regular checks of the fuel system are needed to protect you and the vessel.

#### **!!! DANGER**

Static electricity can ignite gasoline vapors causing serious injury, death and /or destruction of property.

#### 6.2.1 Before Fueling

- Shut down the engines and turn off all electrical devices including the batteries.
- Close all hatches, portlights, and doors to prevent accumulation of fuel vapors.
- Extinguish cigarettes or other lighted materials.
- Keep a properly charged and correctly rated fire extinguisher nearby.

#### 6.2.2 During Fueling

- Use common sense and obey all safety regulations related to fuel handling.
- Avoid static sparks by maintaining contact between the fuel nozzle and fuel fill.

#### 6.2.3 After Fueling

- Secure the fuel cap and inspect for leaks.
- Clean up any spilled fuel and dispose of the cleaning material accordingly. Do not store fuel soaked material on your boat.
- Open all hatches, portlights, and doors to allow for ventilation.
- Check for fuel vapors using a “sniff test” and do not turn on electrical devices, including batteries, until you are certain the fumes have dissipated.

## 6.3 FUEL SYSTEM

Due to the nature of the hull design, your World Cat is equipped with a port and starboard fuel system. These systems act independently, providing fuel to the engine on their respective side. Tanks are constructed of polyethylene material to prevent corrosion.

Hose are NMMA certified, and fittings are clamped securely to reduce the potential for leaks. However, comprehensive checks of hoses and fittings should be completed at least annually, including those normally hidden from view. Tighten all connections, replace deteriorated hoses, clamps or fittings, and replace the fuel/water separators during this check. World Cat has provided inspection plates in the cockpit floor and along the gunwales to assist you with annual maintenance. To access the inspection ports along the gunwale, you will need to remove the cockpit bolsters by removing the screws that hold it in place. To access the screws, pull up gently on the bottom of the bolster and locate the drain grommets. The factory installs screws in every other grommet to secure the bolster. Remove these and pull up and out on the cushion to remove.

If you experience fuel flow problems, remove the fuel feed hose from your engine and connect it to a portable fuel tank. Doing so will help you determine if your fuel system or the engine is the source of the problem. Fuel system repairs and engine maintenance should be performed by a qualified marine technician.

The fuel/water separators are installed between the tank pickup and the engine. They are located in the aft rigging space. Inspect these filters regularly and replace when needed.

### 6.3.1 Fuel System Benefits

- Automotive style refueling
- Automotive Nozzle shut-off
- Fuel Nozzle retention
- System send signal to the pump nozzle to shut off before there is any spit-back through the fill opening
- Overfill protection – reducing the possibility of accidental fuel spills
- Reduce hydrocarbon emission through the use of specially designed fuel fill. The fuel fill has a permanently attached cap with a positive closure mechanism with an audible click, to let you know when the cap is sealed.

### 6.3.2 Fuel Tank

Your boat is equipped with a Low Permeation Crosslink Polyethylene fuel tank with a fuel capacity of 121 gallons per tank. The useable capacity of the fuel tank is different from the tank capacity marked on the tank from the manufacturer. The difference is the ullage area that has been incorporated into your tank. It is recommended that you follow all the instructions regarding the filling of fuel tanks.

### 6.3.3 Fuel Vent

The fuel tank vent is integrated into the fuel fill deck fitting (See fig. 6.3.6) The vent serves as an over pressure/vacuum release with anti-surge and flame/spark arresting protection. The fuel vent system also plays an important role in controlling the “FULL” level of fuel with the use of FLVV (Fill Limit Vent Valve). Grade Valves have been added to the tank which allows proper ventilation of the tank when the boat is stored, or trailered, on a moderate incline, without fuel. Note all ways inspect to insure the fuel fill deck fitting is free of debris and in proper working condition.

### 6.3.4 Fuel Distribution System

The fuel is delivered from the tank to the engine through the “Interated Fuel Demand Valve” (IFDV), anti-siphon valve, and the fuel line. The IFDV prevents the built up pressure inside the tank from being transferred to the engine while still allowing fuel to flow as the engine requires it for operation. The anti-siphon valve is a safety feature designed to prevent the fuel from siphoning out of the tank if the fuel line were to be cut or broken below the level of the fuel in the tank. In this case, some fuel would leak from the line, but will not allow the entire contents of the tank to siphon into the boat. (See fig 6.3.6)

### What does the IFDV do?

- The integrated fuel demand valve, used in conjunction with integrated fuel systems, is for below deck use, eliminates pressurized fuel from reaching fuel distribution lines and your engine and ensures that fuel is provided to the engine on demand rather than as a result of pressure in the tank. Additional features include:
  - Compatible with Ethanol blended fuels
  - Eliminates the need for rigid fuel distribution lines in pressure relief systems (per ABYC H-24.15.9)
  - 2 year warranty



### 6.3.5 Filling Fuel Tanks

The fuel system is desinged to automatically shut off the fuel nozzle when the tank is full by the “Inlet Control Valve” (See Fig 6.3.6) similar to an automotive fuel system. The tank is filled when the fuel fill nozzle has shut itself off the second time. Attempting to fill the tank past this point may cause some of the components to not function properly, or malfunction.

#### **!!! WARNING**

The use of a portable fuel tank to fill your fuel tanks can result in overfilling and circumvent the safety features designed into your fuel tank system.

#### **!!! WARNING**

Modification of any of the fuel system components or the replacement of these components with unathorized parts may result in over-pressurization of the fuel system and circumvent the safety features designed into your fuel system.

### 6.3.6 Pressure Relief Fuel System Diagram

## Pressure Relief Fuel System

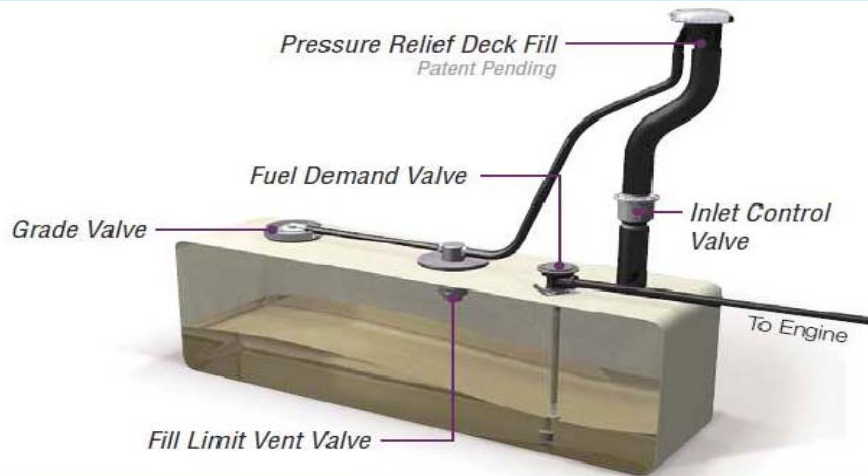

### 6.3.7 Trouble Shooting Tips

#### Possible Failures

- Loss of prime on the engine and or fuel starvation.
  - Symptom Engine runs normally stalls out.
  - Engine runs lean.
  - Engine does not draw fuel properly.
- Corrective action.
  - Possible leakage points
    - Fuel line leak from tank to engine – replace components as needed
    - IFDV O-Ring – replace O-Ring
    - Pick up Tube O-Ring – Replace O-Ring
    - IFDV – Replace IFDV

### 6.3.8 Integrated Fuel Demand Valve Components

#### IFDV Components



#### 6.4 ETHANOL-BLENDED FUEL

Ethanol is an oxygenated hydrocarbon compound that has a high octane rating, therefore is useful in increasing the octan level of unleaded gasoline.

##### NOTICE

The use of improper gasoline or additives can damage your fuel system and is considered misuse of the system. Damage caused by improper gasoline or additives WILL NOT be covered under warranty.

#### 6.4.1 Additives

There is no practical additive known that can prevent or correct phase separation. The only solution is to keep water from accumulating in the fuel tanks.

If phase separation does occur, your only remedy is to drain your fuel tanks, clean and dry the tank completely and refill with fresh fuel.

#### 6.5 ELECTRICAL SYSTEM

The electrical system on your catamaran consists of three major components: the battery system, wiring and circuit protection, and accessories. It is important that you understand the principles of the electrical system, so that you can protect the components and troubleshoot any problems you experience.

## 6.6 BATTERY SYSTEM

Your World Cat is equipped with four batteries. Two of the batteries are dedicated as “cranking batteries” the third & fourth bank controls the DC accessories and is commonly referred to as the “house” bank. To help maintain your batteries, a management system is installed on your boat. This system, controlled by a panel similar to the one shown below, enables you to engage or disconnect the batteries, distribute electrical charge, and parallel batteries in the event of a failure. Chapter 10 of this manual will provide details regarding the location and wiring of your batteries and management panel.

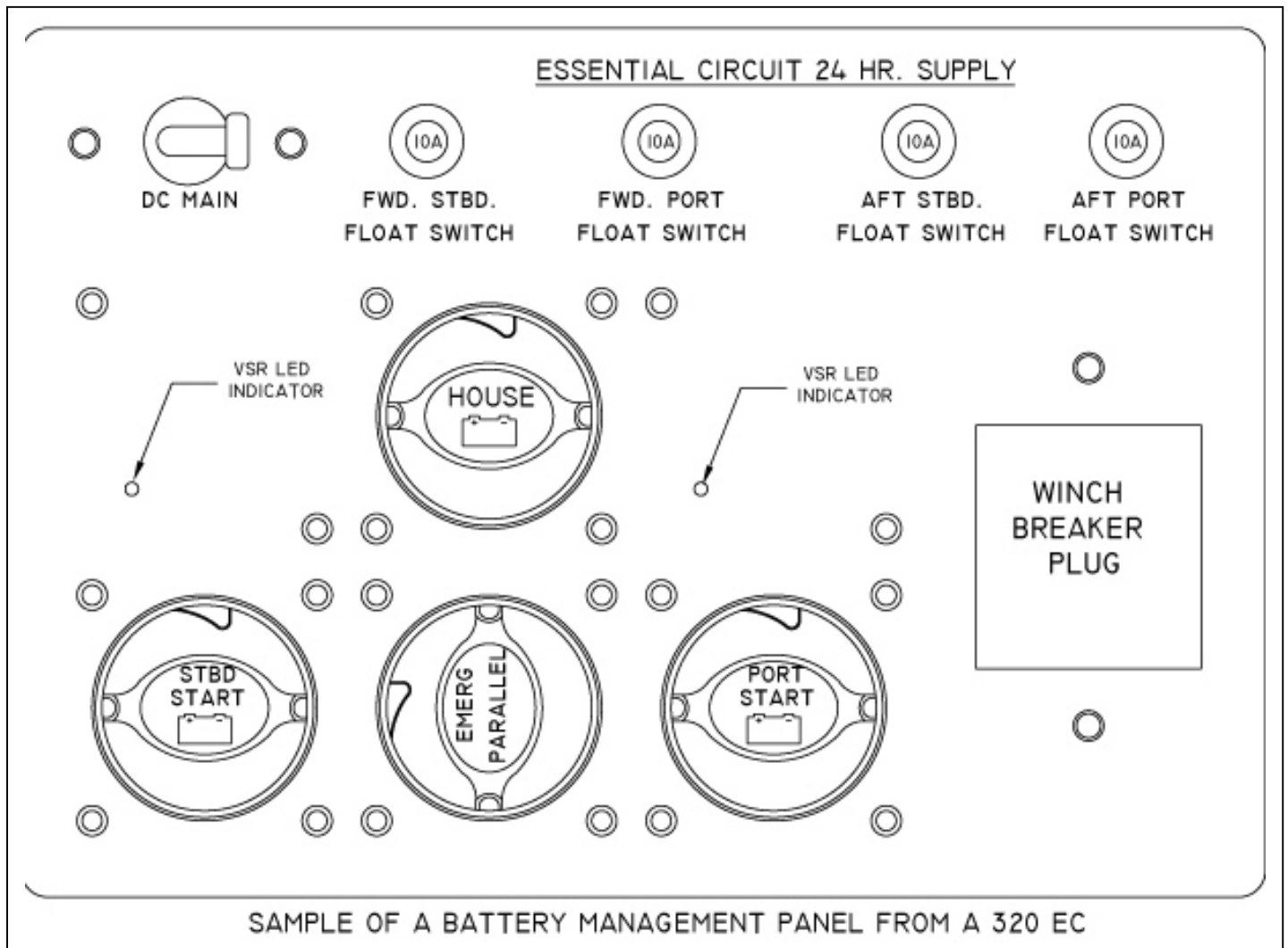

### 6.6.1 Battery Distribution

The drawing above illustrates the normal operating position for the battery management panel. The “PORT START”, “STBD START”, and “HOUSE” switches as well as the “DC MAIN” breaker are in the “ON” position and the “EMERG PARALLEL” is “OFF”. In this position, you are supplying power to the engines through the cranking leads and to the DC accessories through the 50 Amp “DC MAIN” breaker. When you have finished your trip, turn the “PORT START”, “STBD START” and “HOUSE” switches off prior to leaving the boat. The “DC MAIN” can remain “ON” at all times.

### 6.6.2 Voltage Sensor Relay (VSR)

The twin voltage relay sensors are integrated into the battery switch cluster. They distribute the charging output from the engine alternator to the “cranking” and “house” batteries. After starting an engine, the alternator sends electricity back to the “cranking” battery to recharge it. Once the “cranking battery” is fully charged (13.6 volts), the VSR closes to allow the alternator output to charge the “house” battery. When the VSR is operating, the LED indicator located on the management panel will be lit. It will remain lit until the battery is fully charged, or the “cranking” battery voltage falls below 12.8 volts. It is common for the VSR to cycle “ON” and “OFF” during operation. However, constant cycling could indicate a problem in the system and should be checked by your dealer.

### 6.6.3 Emergency Parallel

In the event of a battery failure, the “EMERG PARALLEL” switch allows you to mechanically link the port “cranking” battery to the starboard engine or vice versa. The switch should remain in the “OFF” position when not in use. To prevent voltage spikes or drops which can damage electrical components, you cannot draw power from the house battery using the “EMERG PARALLEL” switch.

### 6.6.4 24 Hour Circuits

The push-in or toggle style breakers located across the top of the management panel protect the 24 hour essential circuit wiring. Per NMMA and USCG guidelines, these breakers are constantly energized to provide power for bilge pumps and memory functions. This helps to protect your vessel even when you are not available. The “HOUSE” switch does not need to be “ON” for these breakers to have power. Inspect the breakers regularly, and push-in or flip the toggle to reset. If a breaker trips constantly, have your dealer investigate the problem as soon as possible to prevent damage to your boat.

#### **NOTICE**

Windlasses used incorrectly could cause harm to equipment or crew  
Windlasses should be used with care and treated with respect  
Lewmar windlasses are designed and supplied for anchor control in marine applications and are not to be used in conjunction with any other use.  
It is the unaboidable responsibility of the owner or master or other responsible part to assess the risk of any operation on the vessel.

### 6.6.5 Anchor Windlass

A 50 Amp breaker is installed at the factory for the anchor windlass. Windlass Deck Switch Maintenance. Refer to section 7.11 for details on maintenance provided by Lewmar

### 6.6.6 Windlass Deck Switch Maintenance

Refer to section 7.11 for details on maintenance provided by Lewmar

#### ***!!! DANGER***

Disconnect the battery cables from the batteries prior to removing or working on the battery management panel. Failure to do so could result in electric shock. Reference the NMMA pamphlet in your “Owner’s Portfolio” for more information.



## 6.7 BATTERY SELECTION

World Cat supplies the original batteries onboard your vessel. We use both Group 27 and Group 31 batteries. In the event of a failure, replacements must be of equal size and specifications (see below):

**GROUP 27 (27MG)**

**CCA: 840**

**MCA: 1050**

**RESERVE CAPACITY: 182 min @ 20A**

**GROUP 31 (GDP31DT)**

**CCA: 700**

**MCA: 875**

**RESERVE CAPACITY: 182 min @ 25A**

## 6.8 BATTERY CARE

Batteries should be secured in a non-metallic tray and insulated boots should cover the terminals. Depending on the style of battery you choose, inspect the electrolyte and perform routine maintenance as suggested by the manufacturer. Remove corrosion from the terminals quickly to prevent failure. Use a stiff brush and a solution of water and baking soda to remove corrosion, then grease the terminals to prevent further build-up. Be careful to clean up thoroughly to avoid contaminating the electrolyte.

When servicing the batteries, follow the safety procedures shown below and work to avoid electrolyte spills which can harm you and your vessel.

### **!!! DANGER**

All batteries contain an electrolyte, commonly sulfuric acid, which is a caustic and volatile chemical. Use extreme caution when charging or servicing.

#### 6.8.1 Safety

- Use protective clothing and accessories such as aprons, gloves, and eye wear to protect yourself while servicing batteries.
- Avoid cigarettes, open flames, and sparks. Batteries can produce toxic and explosive gases; therefore, store or charge them in a well ventilated space.
- Keep batteries out of the reach of children and pets.

#### 6.8.2 Exposure

If you are exposed to the electrolyte solution, follow these procedures and seek immediate medical attention.

**EXTERNAL** - Flush with large amounts of water for contact with the skin. If severe irritation occurs or it contacts your eyes, seek medical attention immediately.

**INTERNAL** - Consume large amounts of water or milk, coupled with milk of magnesia, a beaten egg, or vegetable oil. Seek medical attention immediately.

The guidelines above are basic and do not alleviate the owner of responsibility should an accident occur. Use good judgement and common sense to avoid an accident.

### **!!! CAUTION**

When reconnecting your batteries, always connect the black cable to the negative terminal and red cable to the positive one. Reversing them can damage your electrical system and create the potential electric shock.

### **!!! CAUTION**

Never disconnect a battery while underway. Doing so may result in damage to your boat's electrical system and the engine's alternator.

## 6.9 WIRING AND CIRCUIT PROTECTION

Your World Cat are wired using marine grade tin coated copper wire, instead of standard copper wire. Tin coated copper is manufactured to withstand the harsh saltwater environment better than standard copper, which is used for residential applications. Environmentally sealed Deutsch™ connectors are installed on all accessories located below the waterline to ensure watertight connections. The remaining devices are installed with high quality splices and terminals, which are heat shrunk to protect the integrity of the connection. Harnesses are routed through PVC rigging tubes to prevent chaffing and covered with sheathing when necessary.

## 6.10 CONTROL SYSTEM

Your World Cat is equipped with a traditional switch operated DC control system. In the traditional setup, circuit protection is located above the switches on the instrument panel. A label is mounted on the control unit to advise you which breaker controls a given appliance. If a breaker trips simply push it in to reset. When possible have your dealer replace defective electrical components. If that is impractical, be certain to use identical replacements to ensure the integrity of the system.

**!!! CAUTION**

Failing to use the correct replacement breaker could result in failure of the device or damage to the electrical system. Contact your dealer for repair information.

Accessories not integrated into the control unit can include lights with integrated switches, marine head controls, stereos, aftermarket electronics and 12V outlets. These devices draw current from the accessory fuse blocks. The fuse blocks are similar to those found in automobiles, and use snap-in fuses to protect a circuit. You can obtain replacements for these fuses from your dealer or local auto-parts store. Always replace a damaged fuse with one of equal rating.

Ground blocks are another integral part of your electrical system. These are connected to the common battery ground and individual appliances, to provide a path for current flow back to batteries.

**!!! CAUTION**

When working on your electrical system, disconnect the batteries to prevent shock, or damage to your electrical system. If possible, have an electrician perform repairs.

For customers unfamiliar with electrical systems, World Cat recommends the following book:

**Boating Magazine's:** Powerboater's Guide to Electrical Systems

**Written by:** Ed Sherman

**Publisher:** International Marine (Division of McGraw Hill Companies)

**Copyright:** 2000 International Marine.



## 6.12 ACCESSORIES

Electrical accessories include all lights, pumps, and gauges assembled into your catamaran. Certain accessories are standard to each model, while others are optional equipment. Below is a list of accessories and their function. Beside each accessory is a list of the boats on which the item is standard. For information on optional equipment see Chapter 10 in this manual.

### 6.12.1 Navigational Lights

Per USCG guidelines, all powered vessels must have navigational and anchor lights. Every World Cat is equipped with navigational lights at the bow, a pole light near the stern, or mast light on the hardtop. These lights must be used in accordance with USCG regulations when anchored or underway.

### 6.12.2 Cockpit Lights

Cockpit lights are located at floor level to provide light while operating in low light conditions.

### 6.12.3 Rigging Lights

Rigging lights are located in boxes or rigging spaces to provide light while operating in low light conditions.

### 6.12.4 Cabin / Console Lights

Lights located in the cabin or in consoles have an integrated power switch and are tied directly into the fuse block. Operate them with the switch located at the base of the light.

### 6.12.5 Spreader Lights (Standard on Hardtop)

Attached to the hardtop or hardtop frame, spreader lights illuminate the cockpit in low light situations. They are operated using the switch on the dome light or instrument panel and are protected by a fuse block.

### 6.12.6 Dome Light (Standard on Hardtop)

Located under the hardtop radio box, this light features both white and red lamps for nighttime operation. It is powered by the fuse block located in the radio box.

### 6.12.7 Bilge Pump / Float Switch

Bilge Pumps evacuate standing water in the bilge. They can be operated manually, or automatically by the float switch. The float switches are connected to the fuses along the top of the battery management panel.

### 6.12.8 Raw Water Pump

Supplies pressure to the raw water system. It contains a pressure switch similar to a residential well pump. You can leave this appliance on at all times while underway.

### 6.12.9 Freshwater Pump

Supplies pressure to the freshwater system. It contains a pressure switch similar to a residential well pump. You can leave this appliance on at all times while underway.

### 6.12.10 Livewell Pump

Supplies water to the livewell system and is activated by rocker switch.

### 6.12.11 Macerator Pump

Used to evacuate waste and debris from fishboxes or to remove waste from marine head holding tanks.

### 6.12.12 12v Outlets

Located strategically throughout the boat, these outlets provide power to aftermarket accessories such as cell phones, electric reels, and spotlights. Each outlet is independently wired to the fuse panel.

### 6.12.13 Marine Head

The marine head is powered by the fuse panel, and has a separate control panel mounted near the head. The control panel activates the solenoid to allow for water intake and discharge. A macerator pump is incorporated into the head. See Chapter 5 in this manual for operating instructions.

#### 6.12.14 Anchor Windlass - Freefall

Use to deploy and retrieve the anchor. This accessory is controlled by a dedicated switch at the helm and can also be controlled at the bow with up & down foot switches. The fuse is located at the battery management panel.

#### 6.12.15 Stereo (optional)

Similar to an automotive stereo, the unit can be operated using the faceplate or a remote keypad which is mounted near the helm. It is powered by the fuse block, and the memory wire is connected to a 24 hour circuit.

#### 6.12.16 Windshield Wipers

Operated by a dedicated rocker switch at the helm, these function identically to those found on passenger automobiles.

#### 6.12.17 Horn

Function identically to those found on passenger automobiles.

#### 6.12.18 ACC

“ACC 1” is reserved for the standard freshwater pump on most models. However, the remaining “ACC” switches can be used to operate aftermarket products. ***Be aware of the power requirements for any add-on products, so you do not exceed the capacity of the breaker supplying the switch.*** Failure to do so could damage the appliance and/or the electrical system.

#### 6.12.19 Power steering

The power assist unit provides automobile like steering on your catamaran. The unit is installed in the console between the helm and steering rams. The power for the unit is connected to the port and starboard key switch if you should decide to troll with one engine your power assist will still be operational.

## 6.13 GAUGE PACKAGES

World Cat provides Suzuki™ and Yamaha™ engine packages with manufacturer supplied instrumentation. Below is a list of the standard packages and a description of their function.

### 6.13.1 Yamaha™

Yamaha™ packages feature a dedicated speedometer and fuel management gauge. Instructions on the operation and features of these gauges is included in your engine owner's manual.

### 6.13.2 Suzuki™

Suzuki™ packages feature a three or four piece digital gauge package (same as Yamaha™) with a tachometer for each engine, and a programmable multifunction gauge(s). World Cat setups a preliminary program at the factory, but it can be modified to suit your needs. Instructions on the operation and features of these gauges is included in your engine owner's manual.

## 6.14 PLUMBING SYSTEM

The intake and discharge of water is integral to several of the features and accessories provided on your boat, including livewells, fishboxes, sanitation devices, and water systems. World Cat installs the plumbing components for these systems using high quality marine hoses and stainless clamps. However, this does not eliminate the need for routine checks of plumbing components or connections. A failure resulting from a deteriorated hose or connection, could cause your boat to take on water or become swamped. Information is provided in Chapter 10 of this manual, regarding the location, function, and routing for the plumbing components on your boat. Review these materials and talk with your dealer should you have a question.

## Chapter 7: MAINTENANCE AND SERVICE

### 7.1.1 Overview

This chapter provides basic information for maintaining the original appearance and dependable performance of your World Cat. Although your vessel is constructed of the finest materials available, the harsh saltwater environment and other factors, including geography and usage rate, will affect its finish and function over time. It is imperative that you understand how to care for your catamaran properly. Some simple steps will help maintain its aesthetics, value, and reliability.

### 7.1.2 Gelcoat Maintenance

Gelcoat is a thin layer of resin mixed with colored pigments, which provides the exterior finish on your boat. Gelcoat provides a smooth durable surface to protect the fiberglass construction of the hull, but is still flexible enough to absorb the pressure exerted upon it during operation. Mainly used for cosmetics, gelcoat is relatively simple to maintain. However, without routine cleaning, it will discolor due to the microscopic pores in the surface. Following are some instructions for maintaining your gelcoat.

### 7.1.3 Cleaning

After each trip on the water, or after trailering long distances, you should clean the boat immediately. Washing the boat with mild detergents, such as dishwashing soaps, and fresh water will help eliminate build up or discoloration resulting from environmental pollutants. Use a sponge or other soft cleaning device on the smooth exterior surfaces of the hull and deck. A soft brush can be used when cleaning nonskid portions of the deck. Make sure to rinse the boat thoroughly after cleaning.

**!!! CAUTION**

Using strong or caustic cleaning agents, such as bleach, citrus based cleaners, or one containing ammonia, will damage the appearance and strength of your gelcoat.

### 7.1.4 Waxing

Similar to automotive finishes, gelcoat will begin to fade over an extended period of time. Constant exposure to environmental pollutants and this aging process will result in a loss of shine. However, it is possible to restore the original luster and color using a polishing compound (mild abrasive) or a rubbing compound (harsh abrasive). Each will remove scratches, discoloration, and help restore weathered gelcoat surfaces but you should select what to use based on the severity of the problem. Use the following steps to restore the finish of your gelcoat.

- Clean the affected area completely using a mild detergent.
- Gently wet sand the affected area using a fine sandpaper (600 grit) to remove any stains. Use plenty of water and always sand in one direction using curved strokes. Sanding in alternating directions could result in damage to the finish.
- Apply polishing compound to a buffing pad and follow the manufacturers instructions. If you apply the compound mechanically, we recommend a lamb wool buffing pad and a electric buffer capable of 1750 to 1800 RPM.
- When you have completely buffed the area, wash away any remaining compound using clean water.
- After thoroughly cleaning the surface, wax the affected area. This will help restore the finish and provide a seal against future discoloration.

**!!! CAUTION**

Protect metal surfaces when using abrasive cleaners, polishing compounds or rubbing compounds. They can damage the metal's protective finish leading to rust.



**!!! CAUTION**

When using an electric buffer, maintain constant motion. Allowing the pad to rest on an isolated spot can cause heat buildup, which can damage the gelcoat.

**!!! CAUTION**

Routinely clean and wax your catamaran to help prevent the need for excessive use of rubbing and polishing compounds, which over time can deteriorate the gelcoat.

By following the instructions listed above you can guarantee that your catamaran will remain in near showroom condition and remain a source of pride for years to come.

### 7.1.5 Repair

Although gelcoat is a flexible material capable of handling environmental punishment and extended use, it is susceptible to scratches, blistering and cracking over time. Gel coat distortion or cracking is unappealing, but rarely represents any structural failure. Have your dealer inspect any damage to your gelcoat to determine the nature of the failure. If it is only cosmetic, they can provide color matched kits, instructions, and any chemicals you need for application or cleanup. Structural damage should be repaired by your dealer or a trained fiberglass repair shop.

**!!! WARNING**

Gelcoat and the chemicals used for its application and cleanup are extremely flammable and toxic. Follow all handling and mixing instructions, provide for proper ventilation, and keep water containers nearby to submerge catalyzed materials.

### 7.1.6 Bottom Paint

If you intend to leave your boat in wet storage, or routinely dock it for more than a few days, you should coat the hull beneath the water line with anti-fouling paint. This will help prevent marine growth, such as barnacles, which damage the gelcoat and affect performance. World Cat recommends using an epoxy barrier coat prior to boating painting a new vessel. This will help to prevent, but not eliminate, gelcoat blistering on the hull, which is not warranted by World Cat. Your dealer can provide information on bottom painting to protect against environmental toxins in your area. Anti-fouling paints are made to dissolve over time, so inspect and clean the hull bottom annually and recoat when necessary.

### 7.1.7 Upholstery

**Basic Stains** - Clean with a mild detergent and a soft to medium brush, or an all purpose cleaner such as Fantastic™. Rinse with fresh water after cleaning.

**Mildew** - Use a 4 to 1 mixture of water and ammonia, brushing the stain vigorously to remove the bacteria responsible for the mildew. If the stain remains, briefly apply bleach to the area and rinse with fresh water.

**!!! WARNING**

Do not mix ammonia and household bleach. Doing so will result in the formation of deadly chlorine gas. If it is necessary to use bleach, clean up any traces of ammonia and ventilate the work space for a minimum of 15 minutes prior to applying bleach.

**Tough Stains or Mildew** - Use a mixture of 1 tablespoon of ammonia, 1/4 cup of hydrogen peroxide, and 3/4 cup distilled water. Briefly, apply to the surface, allowing the peroxide to bubble. Rinse with fresh water

### 7.1.8 Trim / Plexiglass / Polyethylene

World Cat uses vinyl, plexiglass, and polyethylene material (Starboard™) throughout the interior of our catamarans. Use the following instructions to care for these items:

- Use mild detergents to clean vinyl trim commonly used in cabins and helm. Routinely use a commercially available surface protector to seal the vinyl.
- Surface or glass cleaners can be used to clean plexiglass. It is commonly used for radio boxes and as a protective material for instrument panels.
- Starboard™ can be cleaned using surface cleaners such as 409™.

### 7.1.9 Stainless / Aluminum

Stainless steel and aluminum are used throughout your vessel. World Cat uses only 316 marine grade stainless hardware and anodized aluminum to provide you with years of service; however, these metals can deteriorate and fail if improperly cared for. Upon returning, clean all hardware using a mild detergent and rinse thoroughly with fresh water. Avoid using abrasive cleaners or chlorine based products, as they will remove the metal's protective coating and lead to pitting or rust. Throughout the year coat the metal using a non-abrasive metal protector to help displace moisture, remove contaminants, and shield the metal. World Cat recommends high quality sealants such as Boeshield T-9™ developed by Boeing™ Aviation. If you cannot find it locally call PMS Products Inc. at 800-962-1732.

### 7.1.10 Bilge Compartments

Routinely check the condition of the bilge compartments in your boat. This will help identify potential problems and eliminate odors associated with stagnant water and the buildup of residue. Clean the compartments using a freshwater rinse. This will also enable you to check the function of your drain system and the operation of the bilge pumps.

### 7.1.11 Cockpit Drains

Your World Cat has four drains located in the cockpit, two on both the starboard and port sides. These drains are designed to quickly evacuate the cockpit should the boat become swamped. Flushing these drains routinely will ensure the safety of your crew and vessel, as well as, eliminate the potential for odors associated with fish residue. These drains are evacuated through the scuppers located on the hullside. Each scupper has a rubber flap to prevent water from entering the boat. Check this material occasionally to keep them free of debris and in good working condition.

### 7.1.12 Winterization

Routine maintenance checks should be performed prior to each trip in accordance with Chapter 1, but a broader analysis should be done before winterizing your catamaran and prior to the first trip of the season. If your local climate does not require winter storage, complete the following steps at least annually to ensure the safe operation of your boat.

- Do not leave loose items or personal affects onboard during storage. Remove all trash and debris prior to cleaning the boat.
- Before storage clean the boat thoroughly, including exterior surfaces, fishboxes, livewells, and thru hull fittings. If possible leave lids open slightly to allow fresh air exchange. Remove the garboard drains and store the boat with the bow up to allow drainage.
- Inspect all electrical connections and the operation of pumps or other electrical devices. Perform repairs if necessary. Coat electrical panels with an anti-corrosive spray, available from your dealer.
- Inspect the batteries and charge fully to prevent damage during storage. Disconnect the cables and apply a coat of grease to the terminals to prohibit corrosion.
- Inspect all plumbing components and connections to prevent leaks. Replace any damaged hoses. Drain all lines and devices to prevent damage from freezing. Lubricate valves to maintain proper operation. Use the manufacturers recommendations for portable and marine heads.

- Inspect fuel system components and replace fuel/water separators. You can keep the system fuel but do not overfill, and use a fuel additive to prevent condensation.
- Lubricate hinges and coat all metal surfaces with Boeshield T-9™ or other metal protector. Tighten down hardware if necessary.
- Inspect caulking around hardware, windows, hatches, etc. to prevent water damage. Normal use will break down sealants and can lead to costly repairs if not maintained.
- Remove or cover all electrical devices to prevent damage from UV rays. The rays will cloud electrical displays and make them hard to read.
- Remove cushions and store indoors to prevent damage.
- Winterize the engines and controls per manufacturers recommendations and inspect all connections, filters, and parts thoroughly. Replace parts as needed.

7.2 MAINTENANCE SCHEDULE

Maintenance	Each Use	Weekly	Monthly	Each Season	Yearly	As needed
Clean hull below the waterline				X		
Bottom paint the hull					X	X
Check/Replace Sacrificial Anodes			X			
Wash boat hardware and canvas	X		X			
Wax exterior gelcoat				X		X
Clean & protect hardware						X
Clean exterior upholstery	X					X
Clean cabin & interior upholstery						X
Flush engines with fresh water	X					
Spray metal components in bilge			X			
Clean bilge				X		X
Check bilge for leaks	X		X			
Inspect steering & controls	X					
Inspect fuel systems for leaks	X					
Replace fuel filters				X	X	X
Lubricate fuel fill O-rings			X			
Inspect fire extinguisher			X			
Test bilge pump auto switches			X			

7.3 LEWMAR (PROVIDED BY LEWMAR)

## **LEWMAR<sup>®</sup>**

### **DECK SWITCH SERVICE UPDATE**

**JUNE 2011**

#### **Overview**

Electric deck switches operate in a hostile environment and are subject to salt water, extremes of temperature, direct sunlight and UV effect. They are also susceptible to wear and tear following repeated use and can in some instances suffer accidental damage during boat operations. It is therefore recommended that regular visual and functional inspection of the switch, the circuitry and the equipment being controlled is carried out by a competent qualified person on a regular basis.

If any defects are noted on the switch (see point 2.0 below), replacement is mandatory so as to avoid the possibility of a malfunction. It is further recommended that an item of this nature is not intended to remain in service forever. The lifespan will depend upon the weather and UV conditions to which the switch is exposed as well as the amount of use. Therefore, a service lifespan of 3 to 5 years from date of purchase can be expected, after which time it should be replaced. Shorter lifespans could be experienced and the following inspection recommendations are therefore important in ensuring continuing safe operation.

#### **Inspection**

- 1.0 The deck switch and the system it controls should be fully tested in a 'No Load' condition prior to full functional operation as per it's design purpose, before every trip, activity or task. Only after the skipper has satisfied themselves of the safe and functional operations should the equipment be used.
- 2.0 The deck switch should be inspected pre-departure or use paying particular attention to the following:
  - 2.1 Ensure there is no visible damage to the switch
  - 2.2 Ensure there is no noticeable wear to the switch, it's housing, it's button or fixings
  - 2.3 Ensure the rubber membrane over the switch is not sticky or has any deposits or residue from cleaning fluids or other prohibited materials
  - 2.4 Ensure the rubber membrane over the switch does not show any signs of cracks, splits or signs of degradation. This includes a change in colour from shiny to a matt finish
  - 2.5 The main switch housing should not have any visible chips or cracks
  - 2.6 The switch should have a smooth positive feel with a distinct click that can be felt at the point of operation
  - 2.7 There should be no signs of water ingress on any part of the switch assembly
  - 2.8 Ensure that the fixings screws and seal to the deck bulkhead or coach roof are secure, and remain effective in both securing the switch and preventing water ingress
  - 2.9 The switch should not feel spongy and should not make a squelch or bubbling noise due to water ingress when depressed and operated

#### **NOTE**

If any of the points highlighted in 2.0 through to 2.9 are detected during inspection, the deck switches should not be used and should be replaced.

- 3.0 On an annual basis the deck switch should be removed by a qualified electrical technician to carry out the following:
  - 3.1 All the checks detailed in 2.0 – 2.9 of this product service update
  - 3.2 Inspect the underside of the deck switch for signs of corrosion, damage or water ingress
  - 3.3 Inspect the wiring for signs of loose connections or corrosion
  - 3.4 In open circuit mode (OFF) condition the resistance should be checked for a recording on the test meter beyond measurement to confirm no electrical connection.
  - 3.5 In closed circuit mode (ON) condition, the resistance should be less than 3  $\Omega$  (ohms)
  - 3.6 If the switch shows any signs of excessive wear, degradation in it's action, water ingress or loss in it's electrical resistance properties, it should be changed immediately

## **LEWMAR<sup>®</sup>**

---

### **DECK SWITCH SERVICE UPDATE**

**JUNE 2011**

#### **Additional Guidance**

- 4.0 It is the responsibility of the skipper to ensure that crew members are trained in the operation of powered deck equipment and use it in a safe and appropriate way within its designed operating parameters. This includes what to do in an emergency.
- 4.1 It is the responsibility of the skipper to ensure that crew members are appropriately briefed on all three methods of equipment isolation in event of emergency, i.e. :-
  - 4.1.1 The switch itself and its operation
  - 4.1.2 The circuit breaker on main panel
  - 4.1.3 The main battery isolation
- 4.2 Crew briefings should always cover the following issues pertaining to deck switch operated equipment:-
  - 4.2.1 Safe operation of any powered deck equipment.
  - 4.2.2 What to do in the event of an emergency
  - 4.2.3 What not to do in event of emergency
  - 4.2.4 A practical demonstration of the effective isolation of deck equipment as highlighted in point 2 above
- 4.3 Deck switches are designed to be used in conjunction with Lewmar equipment only. If they are to be used for the powering of any other electrical equipment the intended use should be checked against the specification of the switch.
- 4.4 Deck switches should only be operated with fingers, bare feet or soft soled shoes.
- 4.5 Switches should be left with the lid closed to minimise environmental degradation and the potential for accidental operation.
- 4.6 Powered deck equipment should always be isolated when not in use to prevent accidental start up.
- 4.7 The instructions for the equipment being operated should always be read and followed.
- 4.8 Power washers should not be used on or near any switch.
- 4.9 It is acknowledged that deck switches will need to be washed down as part of a deck cleaning process. However, direct flow from a non pressure hose should not be aimed at the switch.
- 4.10 The deck switch itself should only be cleaned with a mild soap and washed off immediately with a light application of fresh water.
- 4.11 The following (non exhaustive) list of substances should not be applied, or used on or near any deck switch. Products include but are not limited to:-
  - 4.11.1 Chemicals
  - 4.11.2 Deck cleaners
  - 4.11.3 Petroleum based fluids/cleaners
  - 4.11.4 Deck polish
  - 4.11.5 Deck brightener
  - 4.11.6 Varnish/acquers/paints
  - 4.11.7 Oil

## **LEWMAR<sup>®</sup>**

### **DECK SWITCH SERVICE UPDATE**

**JUNE 2011**

#### **Specific Considerations for Winch Operation Manual B2303 Issue 7**

##### **Winch Operation**

*Please ensure that you thoroughly understand the operation and safety requirements of the winch before commencing the installation. Only persons who are completely familiar with the controls and those who have been fully made aware of the correct use of the winch should be allowed to use it. If there is any doubt of how to install or operate this unit please seek advice from a suitably qualified engineer.*

- *Winches used incorrectly could cause harm to equipment or crew.*
- *Winches should be used with care and treated with respect.*
- *Sailing, like many other sports can be hazardous. Even the correct selection, maintenance and use of proper equipment cannot eliminate the potential for danger, serious injury or death.*
- *Lewmar winches are designed and supplied for line control in marine applications and are to be used in conjunction with appropriate clutches, cleats and other manual controls and stoppers.*
- *It is the unavoidable responsibility of the owner or master or other responsible party to assess the risk of any operation on the vessel.*
- *Under no circumstances should any self tailing winch be used in self tailing mode for any lifting operation; rather suitable and adequate manual tailing should be arranged with proper means of manually cleating or stopping the hoist.*
- *Every winch should be installed with adequate means of manually cleating or stopping the loaded ropes.*

#### **Specific Considerations for Windlass Operation Manual 65001201 Issue 2**

##### **Windlass Operation**

*Classification Societies and Lewmar require that a vessel at anchor must have its rode held by a chain stopper or equivalent strong point at all times!*

*At all times it is the responsibility of the boat user to ensure that the anchor and rode are properly stowed for the prevailing sea conditions. This is particularly important with high-speed powerboats, because an anchor accidentally deploying while under way can cause considerable damage. An anchor windlass is mounted in the most exposed position on a vessel and is thus subject to severe atmospheric attack resulting in a possibility of corrosion in excess of that experienced with most other items of deck equipment. As the windlass may only be used infrequently, the risk of corrosion is further increased. It is essential that the windlass is regularly examined, operated and given any necessary maintenance.*

*Please ensure that you thoroughly understand the operation and safety requirements of the windlass before commencing the installation. Only persons who are completely familiar with the controls and those who have been fully made aware of the correct use of the windlass should be allowed to use it. If there is any doubt of how to install or operate this unit please seek advice from a suitably qualified engineer.*

## **LEWMAR<sup>®</sup>**

---

### **DECK SWITCH SERVICE UPDATE**

**JUNE 2011**

- *Windlasses used incorrectly could cause harm to equipment or crew.*
- *Windlasses should be used with care and treated with respect.*
- *Sailing, like many other sports can be hazardous. Even the correct selection, maintenance and use of proper equipment cannot eliminate the potential for danger, serious injury or death.*
- *Lewmar windlasses are designed and supplied for anchor control in marine applications and are not to be used in conjunction with any other use.*
- *It is the unavoidable responsibility of the owner or master or other responsible party to assess the risk of any operation on the vessel.*

**Additional Information**

- *Lewmar recommends the use of appropriate Personal Protective Equipment and hands free communication equipment by any person going aloft, and only then where the person going aloft is properly trained in the use of that equipment and where there remain sufficient trained and experienced personnel on deck to ensure constant observation and the continued safe conduct both of the vessel and the hoisting operation.*





## Chapter 8: HURRICANE PREPAREDNESS

*North Carolina MARINA / BOATYARD HURRICANE PREPARATIONS*

### CUSTOMER CHECKLIST

#### Equipment To Be Kept On Board:

- chafing gear
- fenders
- two sufficient anchors with 300' or more oversized rode
- flashlight with spare batteries
- battery-operated radio

#### Check Monthly:

- exterior lights operable
- auto bilge pump operating (check battery)
- hatches are watertight
- power and electric gear operating
- engine battery charged
- flashlight battery charged
- radio batteries charged

#### To Do At A New Marina:

- learn marina approaches and basin
- learn the size and type of your mooring
- ensure mooring and lines are sufficient for all likely wind direction and velocity
- ensure mooring has enough weight and scope and is properly set
- learn your moorage lease and rental agreement responsibilities
- learn responsibilities for your boat's safety when a hurricane is approaching
- develop a plan for securing your vessel outside the marina if you plan to evacuate
- if evacuating, visit the site by boat and time the trip
- learn what possible delays you may encounter when evacuating (drawbridges, boat traffic etc.)
- photograph your boat and surroundings
- keep a list of all equipment on board
- keep a list of all equipment that will be removed during storm preparations
- keep a complete set of records for your boat at home
- give the marina operator the name and number of your absentee skipper
- give the marina operator a description of your boat, registration number and location

### DOCKED BOAT PREPARATIONS

- strip all removable items, including spare rigging
- clear self-bailing cockpit drains
- close all through-hull fittings
- set chafing gear where lines will rub (chocks, cross lines, deck edge, dock edge etc.)
- remove portable fuel and oil storage containers
- remove ship papers
- shut off fuel tanks
- leave anchor light on
- leave auto bilge pump on
- check openings to ensure boat is watertight
- set and check storm anchors
- consider attaching 3 sets of bow and stern spring lines
- consider attaching lines to cleats at a 45 degree angle
- consider tying your boat between two piers or along a pier and anchored off one side

North Carolina MARINA / BOATYARD HURRICANE PREPARATIONS

**MOORED BOAT PREPARATIONS**

- Make Plans To Have Someone Pick You Up From Your Boat Before The Storm Arrives
- strip all removable items, including spare rigging
- clear self-bailing cockpit drains
- close all through hull fittings
- remove portable fuel and oil storage containers
- remove ship papers
- shut off fuel tanks
- leave anchor light on
- leave auto bilge pump on
- check openings to ensure boat is watertight
- use storm pennants to increase scope
- attach chains directly to pennants instead of swivels
- add an emergency catenary weight at the vessel end of the chain
- use double or triple chafe protection
- use chafing gear over entire length of pennants
- use two pennants
- if no permanent mooring is available, use two storm anchors at 45-degree angles

**TRAILERABLE BOAT PREPARATIONS**

*Store in a garage:*

- strip all removable items, including spare rigging
- clear self-bailing cockpit drains
- close all through-hull fittings
- remove portable fuel and oil storage containers
- remove ship papers
- shut off fuel tanks
- leave auto bilge pump on
- check openings to ensure boat is watertight
- \_\_\_\_\_
- \_\_\_\_\_
- \_\_\_\_\_

*If no garage is available:*

- secure trailer to a sturdy object
- let half the air out of the trailer tires
- put wood blocks between the frame and axle
- take out the drain plugs
- cover with tarp
- use tie-downs
- \_\_\_\_\_
- \_\_\_\_\_

North Carolina MARINA / BOATYARD HURRICANE PREPARATIONS

**ANCHORED BOAT PREPARATIONS**

*Make Plans To Have Someone Pick You Up From Your Boat Before The Storm Arrives*

- strip all removable items, including spare rigging
- clear self-bailing cockpit drains
- close all through-hull fittings
- remove portable fuel and oil storage containers
- remove ship papers
- shut off fuel tanks
- leave auto bilge pump on
- check openings to ensure boat is watertight
- use 3 or 4 substantial anchors and good tie rope
- tie your boat high on the mainland to a substantial tree or similar structure
- do not tie parallel to the bank
- keep a navigable passage at your stern to allow other boats passage
- use enough line to allow for storm surge
- leave enough room between your boat and others to allow for swing
- take valuables off
- \_\_\_\_\_
- \_\_\_\_\_
- \_\_\_\_\_
- \_\_\_\_\_

## Chapter 9: 2015 WARRANTY POLICY

**1. Ten Year Limited Hull Warranty.** HC Composites, LLC, herein defined as “World Cat”, warrants to the original retail purchaser (“Purchaser”) that for ten (10) years after the date of delivery to its original retail purchaser, each new fiberglass hull (defined as the one piece fiberglass molded part that acts as the vessel's running surface during operation), manufactured by HC Composites, LLC shall be free from structural defects due to material or workmanship under normal non-commercial use. In the event that HC Composites, LLC determines that the boat must be replaced, then the value offered towards the replacement boat is the factory invoice for the boat. Transfer of all accessories including engines will be at the owner's expense. At HC Composites, LLC discretion the replacement model will be an upgraded model if the original model is no longer offered.

**2. One Year Components Warranty.** HC Composites, LLC warrants to Purchaser that for one (1) year after the date of delivery to its original retail purchaser, all boat components manufactured by HC Composites, LLC shall be free from defects due to material or workmanship under normal non-commercial use.

**3. Exclusions.** This limited warranty does not cover and does not extend to any of the following:

(a) Hull or component failure caused by normal wear and tear, climatic conditions, misuse, neglect, lack of proper maintenance, accident, fire or other casualty damage, racing, overloading, negligence, modification, or commercial use; (b) windshield leakage or breakage; (c) repaired or replacement components not installed by World Cat, unless installed by World Cat selling dealer in accordance with this warranty; (d) fading, chalking, blistering or cracking of any varnish, gelcoat, paint, anti-fouling coating, metallic finish or powder coating; (e) tears, cracking, fading, discoloration or mildewing of curtains, cushions, tops, headliners or other fabric or upholstered items; (f) cost of removal or reinstallation of any component (including components manufactured by World Cat), or disassembly and reassembly of the unit containing the component; (g) speed, weight, fuel consumption and other performance characteristics of the boat. **ANY ORAL STATEMENT OR PRINTED ADVERTISING REGARDING ANY PERFORMANCE CHARACTERISTIC OF THE BOAT OR ITS COMPONENTS SHALL BE CONSIDERED AN ESTIMATE ONLY AND SHALL NOT BE RELIED UPON AS EXPRESS WARRANTY OR AS A BASIS OF THE BARGAIN FOR THE BOAT OR ITS COMPONENTS;** (h) electrolysis, galvanic corrosion, crevice corrosion, stray current or any deterioration of underwater components; (i) components not manufactured by HC Composites, LLC, whether or not warranted by the other manufacturer, even if installed by HC Composites, LLC, including but not limited to engines, propellers, generator sets, controls, electronics, batteries, appliances and air conditioning. \_\_\_\_\_(*customer initial*) Warranties provided to HC Composites, LLC by component manufacturers shall be passed on to purchaser to the extent such transfer is permitted by the manufacturer; HC Composites, LLC selling dealer will identify the authorized service dealer for any such components upon request.

**4. Limitations/No other Warranties.** THE REPAIR OR REPLACEMENT OF DEFECTIVE PARTS SHALL BE PURCHASER'S SOLE AND EXCLUSIVE REMEDY AND WORLD CAT SOLE AND EXCLUSIVE LIABILITY UNDER THIS WARRANTY. HC Composites, LLC obligation under this warranty is limited to the repair or replacement (at HC Composites, LLC sole election) of any covered item found to be defective, when delivered by Purchaser pursuant to written authorization and instructions from HC Composites, LLC, round-trip transportation prepaid, to HC Composites, LLC manufacturing plant or other designated repair facility \_\_\_\_\_(*customer initial*). Repaired or replaced items are warranted as provided herein for the unexpired portion of the applicable warranty period.

THIS WARRANTY, AND THE RIGHTS AND REMEDIES UNDER IT, IS EXCLUSIVE AND IS GIVEN IN PLACE OF ALL OTHER WARRANTIES, WHETHER EXPRESS OR IMPLIED, INCLUDING ANY IMPLIED WARRANTY OF MERCHANTABILITY OR FITNESS FOR PARTICULAR PURPOSE, WHETHER ARISING BY LAW, CUSTOM, CONDUCT OR USAGE OF TRADE. PURCHASER'S REMEDIES SHALL BE LIMITED AS STATED HEREIN AND HC COMPOSITES, LLC SHALL NOT BE LIABLE FOR ANY INCIDENTAL, CONSEQUENTIAL OR INDIRECT DAMAGES OR LOSSES RESULTING FROM DEFECTS.

THIS LIMITED WARRANTY GIVES PURCHASER SPECIFIC LEGAL RIGHTS. PURCHASER MAY HAVE OTHER RIGHTS WHICH MAY VARY FROM STATE TO STATE. IN THE EVENT THAT IMPLIED WARRANTIES ARE FOUND TO EXIST UNDER THE LAW OF A PARTICULAR STATE NOTWITHSTANDING THE EXCLUSION CONTAINED HEREIN, THE DURATION OF ANY SUCH WARRANTY SHALL BE LIMITED TO THE DURATION OF THE APPLICABLE LIMITED WARRANTY STATED HEREIN.

THE SELLING DEALER IS NOT A CO-WARRANTOR AND IS NOT AUTHORIZED BY HC COMPOSITES, LLC TO AMEND OR MODIFY THIS LIMITED WARRANTY IN ANY MANNER.

**5. Dispute Resolution.** Any controversy or claim arising out of or related to this Agreement or to the relationship created hereby, whether at common law or under statute, shall be settled exclusively by binding arbitration conducted in Edgecombe County, North Carolina, pursuant to the North Carolina Commercial Arbitration Act (the "Act").

**6. Predelivery Examination.** Purchaser represents to HC Composites, LLC that Purchaser has examined the boat and all its component parts, accessories and equipment, to Purchaser's full satisfaction prior to accepting delivery of the boat from HC Composites, LLC, or in the alternative, has been given full opportunity to do so and has declined. \_\_\_\_\_(Customer initial)

**7. Single Transferability of Warranty.** Coverage remaining under the Warranty Periods may be transferred by an Authorized HC Composites, LLC, Dealer to a 2<sup>nd</sup> purchaser for a \$395.00 fee. The transfer must occur within five (5) years of the original date of retail sale. The transfer fee must be paid within thirty (30) days of purchase of the used boat to transfer the warranty. A copy of the bill of sale from the original owner or Authorized World Cat Dealer is required and completion of this form. HC Composites, LLC, reserves the right to reject any warranty transfer request for a boat that has been damaged, neglected or otherwise previously excluded from warranty.

**8. Miscellaneous.** HC Composites, LLC reserves the right to make changes in the design and construction of its products at any time, without notice and without any obligation to incorporate such changes into products of prior manufacture. This limited warranty applies to new boats manufactured by HC Composites, LLC, except as such limited warranty may be transferred to a subsequent purchaser as provided herein. The term "new boats" shall include boats that may have been repaired during the manufacturing process as part of HC Composites, LLC quality assurance program. This limited warranty contains the entire agreement between HC Composites, LLC and Purchaser and supersedes all prior agreements, discussions, negotiations, commitments and representations, whether oral or written, between them regarding HC Composites, LLC warranty. If any provision of this limited warranty, or the application of it, is determined to be invalid or unenforceable for any reason, the remainder of this limited warranty and the application of it shall not be affected.

All communications and notices from Purchaser regarding this limited warranty should be sent to: HC Composites, LLC, 1090 West Saint James Street, Tarboro, NC 27886 or fax to 919-882-9357

**9. Acknowledgment of Limited Warranty.** By signing below, Purchaser (or each Purchaser, if more than one) agrees that he or she has read this limited warranty in its entirety and understands its terms and conditions. Purchaser (or each of them) acknowledges receipt of a copy of this limited warranty at the time of the sale.

WARRANTY REGISTRATION

\_\_\_\_\_  
Purchaser's Name

\_\_\_\_\_  
Purchaser's Phone Number

\_\_\_\_\_  
Purchaser's Street Address

\_\_\_\_\_  
Date of Delivery

\_\_\_\_\_  
Purchaser's City, State and Zipcode

\_\_\_\_\_  
Hull Identification Number

\_\_\_\_\_  
Purchaser's Email Address

\_\_\_\_\_  
Name of Selling Dealer

\_\_\_\_\_  
Purchaser's Signature

\_\_\_\_\_  
Dealer's Sales Representative

Original Owner

Second Owner

## Chapter 10: 320EC OPERATION AND SCHEMATICS

### 10.1 OPERATION OF STANDARD EQUIPMENT

#### 10.1.1 Battery Layout and Management

Your 320EC is equipped with four batteries which are located in the aft rigging compartment. They can be reached using the access hatches located on the vertical wall behind the port and starboard jumpseats. A cranking battery and house battery are installed on each side. Wire leads run forward to the battery management panel which is located on the vertical wall of the starboard lounge seat thru a rigging tube in the starboard battery compartment (*See Chapter 6 for information regarding the operation of this panel*). The engine cranking leads are run aft thru the same tube and are connected to a positive stud located on the bulkhead in the each aft rigging compartment. The engine grounds are secured to the cranking battery on its respective side (*see diagram below*).

The house batteries are wired in parallel, and provide the power for all your DC accessories. The main lead running to the battery management panel is attached to the starboard house battery. The lead connects to the “house” switch and is routed forward through the 50 amp “DC Main” breaker located in the top left corner of the management panel. During normal operation the “DC Main” breaker can remain in the “ON” position, and the “house” switch will control battery power. The main ground for all DC accessories is tied into the common ground on all batteries (see diagram below).

For a detailed drawing of the panel connections, see the diagram on page 10-67 of this chapter.

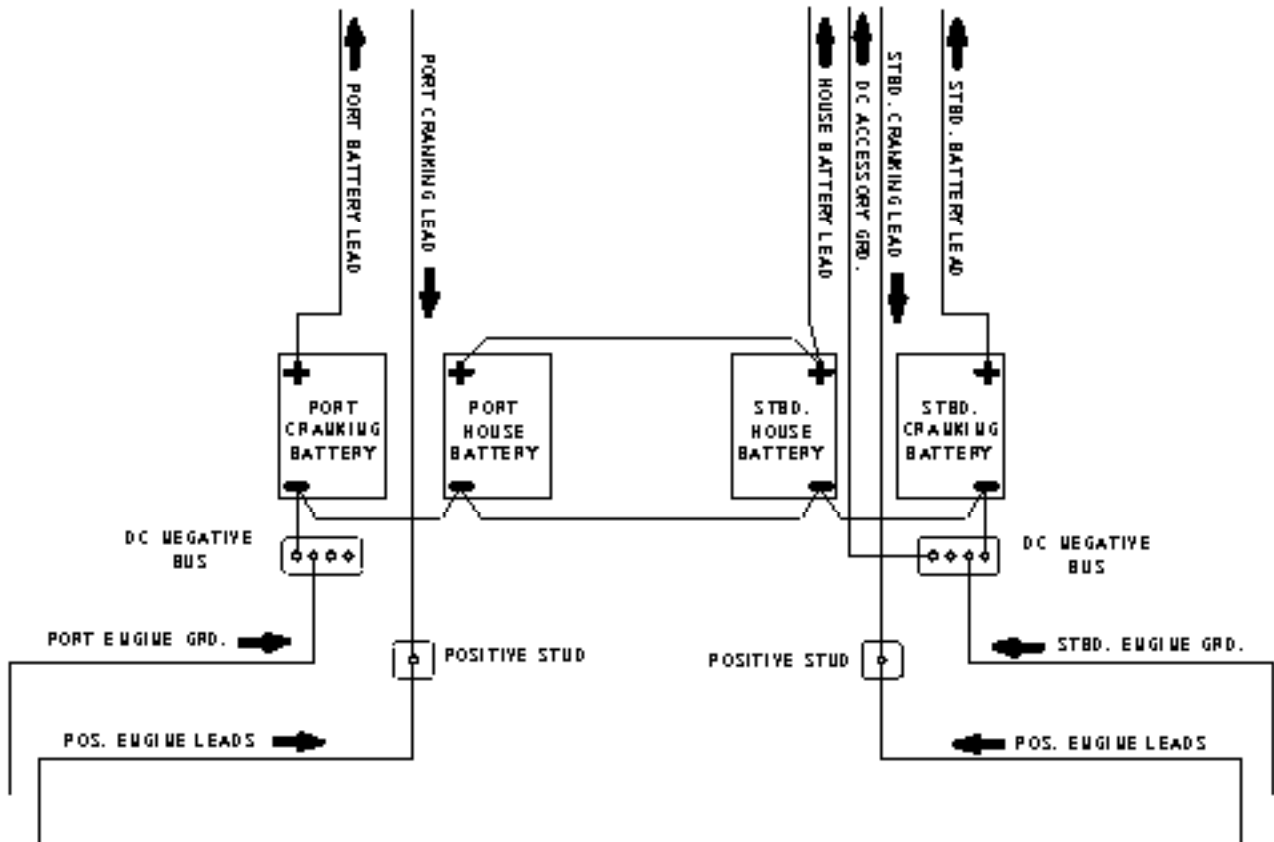

### 10.1.2 Bilge Pumps / Float Switches

Your 320EC is equipped with two 1500 GPH bilge pumps and two 500 GPH bilge pumps. Each pump is connected to a float switch which automatically triggers the pump when water comes to rest in the bilge. The float switches are connected to the battery management panel and receive power from the breaker along the top of the panel. These breakers are constantly energized and ensure the safety of your boat even when the battery switches are in the “off” position. The pumps can be manually engaged using the switches located on the dash.

The aft bilge pumps are located behind the aft rigging compartment and can be accessed through the inspection plates in the motorwell, forward of the engines. The wiring for these pumps is secured on the outboard side of the centerline stringer which is visible from the inspection port. The forward pumps are located beneath the cabin liner. They can be reached through the inspection ports installed in the cabin floor on either side of the master berth.

Inspect the operation of your bilge pumps and their connections at least annually. To do so, activate the pump by momentarily lifting the arm on the float switch, then check the operation using the switches at the helm. When testing, do not allow the pumps to run dry for more than two to three seconds. Extended dry operation can result in damage to your pump. Keeping your bilge areas clean can also help extend the life of your pump.

### 10.1.3 Shower Sump

To collect discharge water from the galley sink, head sink, and shower drain, a sump is installed in the starboard sponson. The sump is equipped with a bilge pump to evacuate grey water overboard and can be accessed using the hatch in the floor of the head compartment. To gain access remove the screws from the sump cover in front of the head. Check the sump at least twice per year to prevent the buildup of waste which could lead to clogs, more often if the sinks and shower are heavily used.

### 10.1.4 Freshwater System

The freshwater pump and wiring are located under the port lounge seat and can be accessed by removing the tackle unit on the aft vertical wall of the seatbox. The freshwater pump is connected to the freshwater tank also located in this area. The tank is filled through a fitting located on the portdecktop.

To pressurize the freshwater system, use the switch located on the dash instrument panel. Similar to residential well pumps, the freshwater pump will pressurize the system to 45 psi. then shut down until the pressure drops below that level. Most owners leave the pump “on” throughout the day, and use the system when necessary. On the 320EC, the freshwater pump feeds the port freshwater fittings, water heater, galley faucet, head faucet, and marine head. To view the layout of the freshwater system see the drawing in section 11.2.7.

#### **NOTICE**

**During the initial fill of the water tank, or any refills after the system was completely purged, run the freshwater pump to fill the plumbing lines and water heater for extra capacity.**

### 10.1.5 SEACOCKS



Ball valves (seacocks) are installed on the water intake for the livewell and raw water systems. The seacocks must be in the open position for these systems to work. When open, the handle will be parallel to the valve. In the closed position the handle is perpendicular to the valve (see picture below). World Cat recommends that the seacocks remain in the closed position when not in use, or when the boat is left unattended to prevent the vessel from taking on water due to a plumbing failure.



**OPEN**



**CLOSED**

### 10.1.6 Livewell System

The 320EC has a 45 gallon livewell standard, which is equipped with a dual purpose 1100 GPH livewell pump. The pump is located in the aft bilge compartment and can be reached through the inspection port in port motorwell. The wiring is secured along the aft main bulkhead and must be disconnected prior to removing the pump. The livewell pump draws water through the strainer mounted on the inboard side of the port sponson. A seacock is installed between the pickup and the pump to allow you to seal the system between use, or in the event of a plumbing failure.

To operate the livewell, first verify that the seacock is open. Then install the livewell drain plug. When you have completed these steps, engage the livewell pump using the switch on the dash instrument panel. Water will fill the tank until it is level with the overflow, which evacuates water through the hullside. When you have finished using the livewell, remove the drain plug to allow the water to drain overboard. The livewell light is controlled by the cockpit light switch. If you have chosen the second livewell option, the starboard bait prep sink is replaced with a second livewell which works identical to the port system.

**NOTICE**

**While underway, leaving your livewell seacock open could result in inadvertently filling your livewell. To prevent this, close the seacock when the pump is not in operation.**

**NOTICE**

**Operating the engines in reverse can cause ventilation near the livewell intake, causing the pump to airlock. To prevent this, turn the pumps “OFF” prior to any continuous or high speed reverse operation. If your pump becomes air locked, turning the pump “OFF” for 15 to 30 seconds will correct the problem.**

### 10.1.7 Raw Water System

The raw water pump is located in the aft rigging compartment on the starboard side, and can be accessed through the hatch located on the vertical wall behind the aft jumpseat. The pump and wiring are mounted on the rigging wall at the back of the compartment. The raw water pump is connected to the intake strainer located on the inboard side of the starboard sponson. The seacock connected to this strainer must be open for the system to work. Similar to the freshwater pump, the raw water pump is controlled by a switch on the dash instrument panel. The pump will cycle on

and off as needed to maintain 45 psi. Most owners leave the pump “on” throughout the day, and use the system when necessary. On the 320EC, the raw water pump feeds the raw water fitting on the aft vertical wall of the starboard lounge, and the faucet in the bait prep sink. To view the layout of the raw water system see the drawing on 11.2.8.

### 10.1.8 Marine Head

The 320EC comes equipped with a Vacu-Flush™ marine head in the starboard shower compartment. The control panels for the head, shown below, are located on the vertical wall aft the toilet. Power is supplied to the system through the Tank Watch™ panel, which is feed by a 10 amp fuse located on the accessory fuse block at the helm. The LCD lights on the panel also indicate the level of waste in the holding tank.

The second panel, labeled Tank Master™, controls the discharge of waste. Current is supplied to it through a 20 amp fuse also located on the the center accessory fuse block. A macerator pump is wired directly to the panel to evacuate the holding tank when necessary. To operate simply insert the key provided and turn the switch to the “manual” position. You must continue the hold the key until all the waste has been removed.

Water is supplied to the system from the freshwater tank located in the console Therefore, to operate the toilet the freshwater system must be pressurized. The holding tank is mounted in the equipment compartment and can be accessed by removing the bulkhead aft of the toilet.

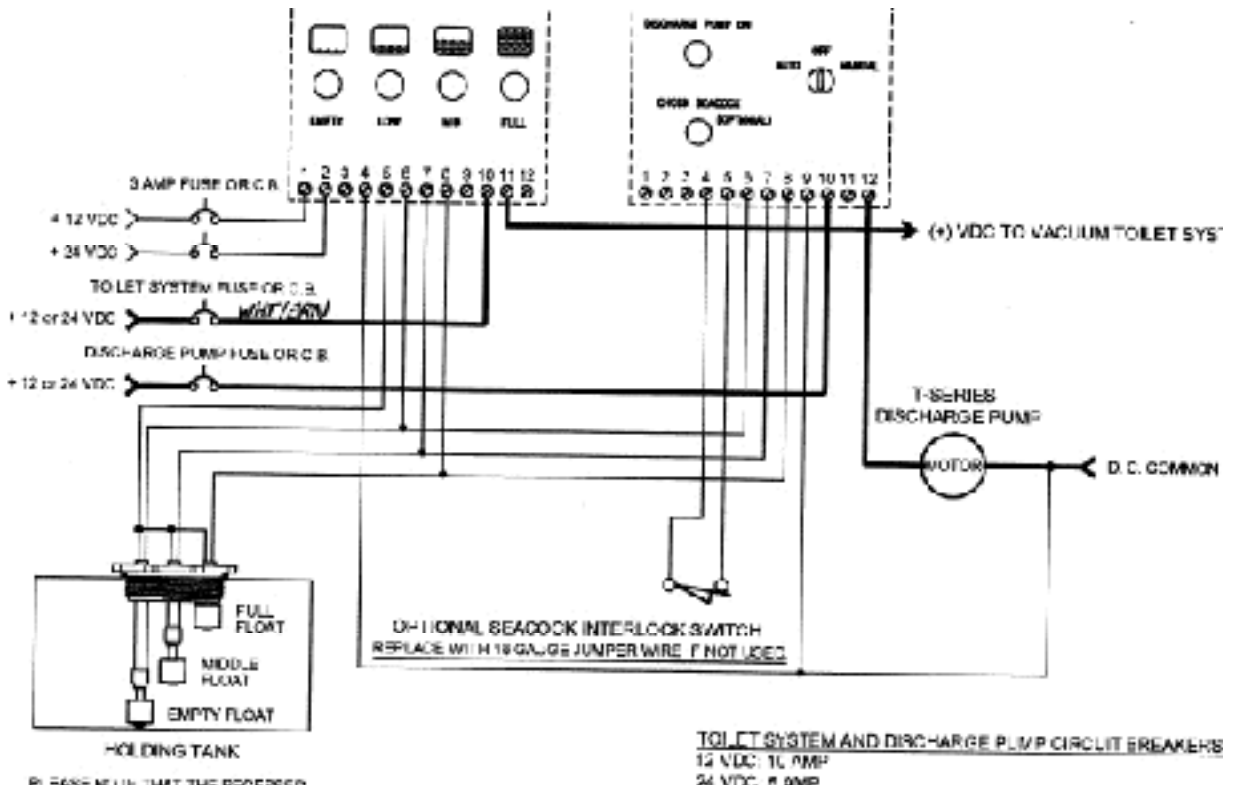

#### 1.1.1.1. Initial Start Up

On each trip, prior to using the head, complete the following steps:

1. Turn on the freshwater system.
2. Fill 1/3 of the bowl with water by lifting up on the flush lever

3. Hold down the flush lever for 5 seconds to evacuate the bowl.

#### **1.1.1.2. Normal Use**

Use the steps below for normal operation.

1. Fill 1/3 of the bowl with water by lifting up on the flush lever
2. Hold down the flush lever for 5 seconds to evacuate the bowl.

#### **! CAUTION**

**Large quantities of waste or paper can clog the head and cause odor issues. To prevent this, flush often and if necessary perform an extra flush to purge the discharge line.**

#### **! CAUTION**

**Do not dispose of foreign objects in the head. Doing so may damage the outlet hoses. Clogging or puncturing these lines will lead to odor problems.**

#### **1.1.1.3. DECK PUMP-OUT**

Upon returning, use the following instruction to empty the holding tank.

1. Remove the cap from the deck pump-out fitting located on the deck, forward of the starboard fuel fill.
2. Use the vacuum hose at the pump-out station to clean the tank, then remove the hose and replace the deck fitting.

#### **1.1.1.4. Overboard Discharge**

Use the following steps to discharge the contents of the holding tank overboard:

1. Remove the access plate located behind the head to open the discharge seacock.
2. Using the TankMaster™ panel, turn the key switch to “manual” to engage the macerator pump. Hold the key in this position until the Tank Watch™ panel reads empty.
3. Close the discharge seacock and replace the access plate.

Marine Head Drawing refer to section 11.2.9

#### **! CAUTION**

**Discharging waste in inland waters and some coastal areas is illegal. Check with local and state authorities in your region to determine the proper method for waste disposal.**

*For more instructions on operation, winterization and troubleshooting the marine head, see the Vacu-Flush™ manual supplied in your “Owner’s Portfolio”.*

### **10.1.9 SHOREPOWER PACKAGE**

Your 320EC comes equipped with a shorepower package which includes a shore power inlet and cordset (30 Amps), AC distribution panel, refrigerator, microwave, five (110 V) receptacles, electric stove, water heater and battery charger. Following are instructions on the function and proper use of these accessories.

#### **1.1.1.5. Connecting Shore Power**

The shore power inlet is located on the outboard vertical wall of the starboard motorwell. Use the following steps to help protect your vessel and yourself.

- Before connecting the cordset, turn the “AC Main” breaker and all accessory breakers to the “OFF” position. The breakers are installed on the AC panel located on the upper galley cabinet in the cabin.
- Connect the cordset to the boat first, by plugging it into the receptacle and tightening the trim ring.
- Once these steps are completed, attach the cordset to the outlet supplied by the marina.

#### **1.1.1.6. Disconnecting Shore Power**

To disconnect the shore power cordset, reverse the procedure above. Turn the “AC Main” breaker and all accessory breakers to the “OFF” position. Unplug the cordset from the marina supplied outlet, then unscrew the trim ring and remove the cordset from boat’s inlet.

#### **10.1.10 AC Panel**

The AC distribution panel is installed in the starboard deckwing above the entrance to the aft berth. This panel houses the circuit breakers for the AC system and its accessories. The panel also contains a reverse polarity indicator. Reverse polarity occurs when the AC power lead (black) and the AC grounded lead (white) are reversed. This can destroy appliances and create the potential for electric shock. Therefore, after attaching the shore power, turn the “AC MAIN” breaker “ON” first and inspect the reverse polarity indicator. If the LED indicator remains unlit, you can engage the remaining accessory breakers. If the indicator light turns red, immediately turn “OFF” the “AC MAIN” breaker and disconnect the shore power. Notify the marina regarding the issue and have a trained electrician inspect your boat to determine if any damage has been sustained by the electrical system.

#### **10.1.11 Refrigerator**

An AC/DC refrigerator is installed in the upper galley cabinet. The refrigerator is similar to any dorm style unit, except it can operate from both the AC and DC systems. The unit is hard wired to the AC panel and will automatically use AC current if it is available, but can operate off battery power while the “HOUSE” battery switch is in the “ON” position.

#### **10.1.12 Microwave**

The microwave is installed in the upper galley cabinet. It operates exactly like a residential unit, and functions only when you are connected to ship or shore power.

#### **10.1.13 Receptacles**

Five receptacles are standard on the 320 EC, one in the cockpit, one at the galley, one in the shower compartment, and two in the forward cabin. The cockpit outlet, port berth outlet, and galley outlet are Ground Fault Circuit Interrupters (GFCI), which are designed to trip the circuit when the resistance along the grounded conductor falls beneath 25000 Ohms. This protects you from electric shock, by stopping the current flow through the receptacle. The head and starboard berth outlets are wired in series with the port berth and galley outlet respectively, to provide fault protection for these as well.

#### **10.1.14 Stove**

A single burner electric stove is provided at the galley. Operation is similar to any residential cooktop.

#### **10.1.15 Water Heater**

A six gallon water heater is installed in the equipment compartment aft of the head. Temperature is controlled using a

thermostat similar to residential water heaters and hot water is provided to the galley and shower faucets.

**! CAUTION**

**Water is supplied to the tank through the freshwater system, therefore the freshwater pump must be engaged prior to energizing this system. Failure to do so can result in damage to the water heater and a potential fire or electrical aboard your vessel**

### 10.1.16 Battery Charger

Combined with the battery management system, this system helps ensure that your vessel will be ready to fish whenever you are. The charger is located in the starboard battery compartment outboard of the cranking battery.

### 10.1.17 LCD TV

The 320EC can be equipped with an LCD TV. The television includes an integrated DVD player. The unit is DC powered, and can be used while underway.

### 10.1.18 Anchor Windlass (Freefall)

Your World Cat is equipped with a free-fall windlass manufactured by Simpson Lawrence™. You will receive the windlass, an anchor, anchor rope, and chain which is matched to your vessel's size. The controls for the windlass are mounted at the helm, and the manufacturer's instruction manual is provided, in the "Owner's Portfolio", detailing its use.

The circuit breaker for the anchor windlass is mounted on the battery management panel. The breaker is connected to a "cranking" battery switch. (see wiring diagram in section 11.2.6).

**NOTICE**

Windlasses used incorrectly could cause harm to equipment or crew. Windlasses should be used with care and treated with respect. Lewmar windlasses are designed and supplied for anchor control in marine applications and are not to be used in conjunction with any other use. It is the unabordable responsibility of the owner or master or other responsible part to assess the risk of any operation on the vessel.

### 10.1.19 Windlass Deck Switch Maintenance

Refer to section 7.3 for details on maintenance provided by Lewmar

### 10.1.20 Teleflex™ Power Assist Unit

The power assist unit provides automobile like steering on your catamaran. The unit is installed near the helm and can be accessed through the hatch located on the starboard lounge seating compartment. The power for the unit is connected to the engine ignition switch.

### 10.1.21 Generator

The Fischer Panda™ generator is installed under the starboard lounge seat, and can be accessed using the hatch located on the seatbox or by removing the tackle unit on the aft vertical wall. Prior to using the generator, review the manual provided by Fischer Panda™ which is included in your "Owner's Portfolio". Follow these startup guidelines before each use of the generator:

1. Verify that the seacock located in the port aft bilge compartment is open.
2. Verify that the "Port Start" battery switch is "ON".
3. Turn off the "Ship Power" breaker and all accessory breakers located on the AC Panel

4. Press the “ON” button on the generator control panel, located on the aft cabin wall, and wait for the unit to perform its self-test. If the LCD screen displays “00000” then proceed to step 5. If an error message is displayed on the LCD screen, do not attempt to start the unit. Contact your dealer and schedule a maintenance check.
5. Use the start button on the control panel to crank the generator.

**! CAUTION**

**If the generator does not start within the first three attempts, turn the panel off and contact your dealer prior to further use. Failure to do so, will result in significant damage to the generator.**

1. Once the generator is running, engage the “SHIP POWER” circuit breaker and verify that the “REVERSE POLARITY” indicator is not lit. If it is not lit proceed to step 7, however, if the red LED indicator is lit, immediately turn “OFF” the “SHIP POWER” breaker and shut down the generator. Notify your dealer regarding the issue and have a trained electrician inspect your boat to determine if any damage has been sustained by the electrical system.
2. You may now engage the AC accessory breakers.

**! CAUTION**

**For safety reasons, the seacock must be closed after the generator has been switched off. It should be re-opened before starting the generator.**

Routine maintenance should be performed on this unit using the guidelines established by Fischer Panda™. Failure to comply with these guidelines will result in loss of warranty coverage and creates the potential for property damage or personal injury.

### 10.1.22 Climate Control Unit

The heating/air conditioning unit is mounted under the port lounge seat. It can be accessed by removing the removing the bulkhead located above the quarter berth on the port side of the cabin.. The filter control panel are located in this bulkhead. Follow these startup guidelines before each use of the unit:

1. Verify that the seacock located in the port aft bilge compartment is open.
2. Using the guidelines provided, energize the AC panel using the generator or shore power connection and engage the corresponding circuit breaker.
3. Using the control panel, energize the climate control unit and select the operating mode and desired temperature using the selection tools. This will engage the raw water pump located in the port aft rigging compartment.
4. Once the unit is running, inspect for water flow through the system by checking the thru-hull located on the port sponson (see Thru-Hull drawing section 11.2.10). If water is not flowing, shut down the unit immediately to prevent damage. Then have your dealer inspect the system.

Similar to a residential system, the filter units must be replaced at regular intervals to ensure proper operation. Use the manual provided in your “Owner’s Packet” to obtain requirements for service, and to get recommendations on usage.

## 10.2 MAXIMUM HORSEPOWER RATING: TWIN 300 4-STROKE HP (600 HP TOTAL)

## Chapter 11: OPERATION OF OPTIONAL EQUIPMENT

### 11.1.1 Stereo

If chosen, your 320EC can be equipped with an optional stereo unit. The unit is mounted in the starboard storage shelf, with 2 speakers mounted in the forward cabin and two in the hardtop radio box. You can control the unit using the faceplate or the remote located at the helm. Power is supplied to the stereo through the accessory fuse block, therefore, the “house” battery switch must be in the “on” position to use the unit.

### 11.1.2 Outriggers

Outriggers enhance the fishability of your catamaran and can be a great asset when hunting a trophy catch. World Cat offers 18' Taco™ outriggers as an option on the 320 EC. The units are mounted on the fiberglass hardtop and operated using the handles above and outboard of the console. Use the information provided in Chapter 7 to maintain the aluminum on the outriggers and grease the telescoping joints frequently to prevent damage from salt spray.

## 11.2 SYSTEM DIAGRAMS

### 11.2.1 Access Plate and Rigging Tube Diagram

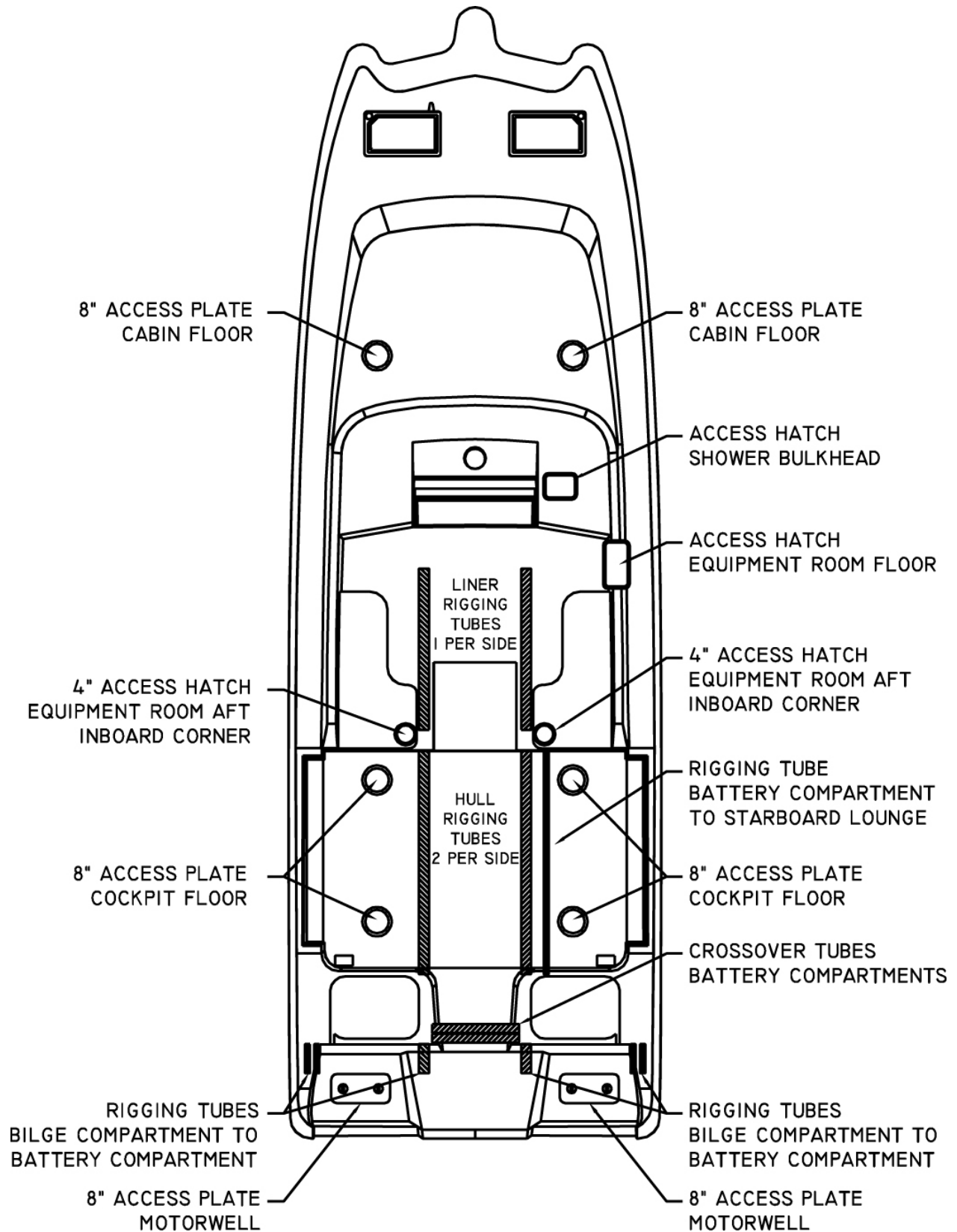



## 11.2.2 Hull Wiring Diagram

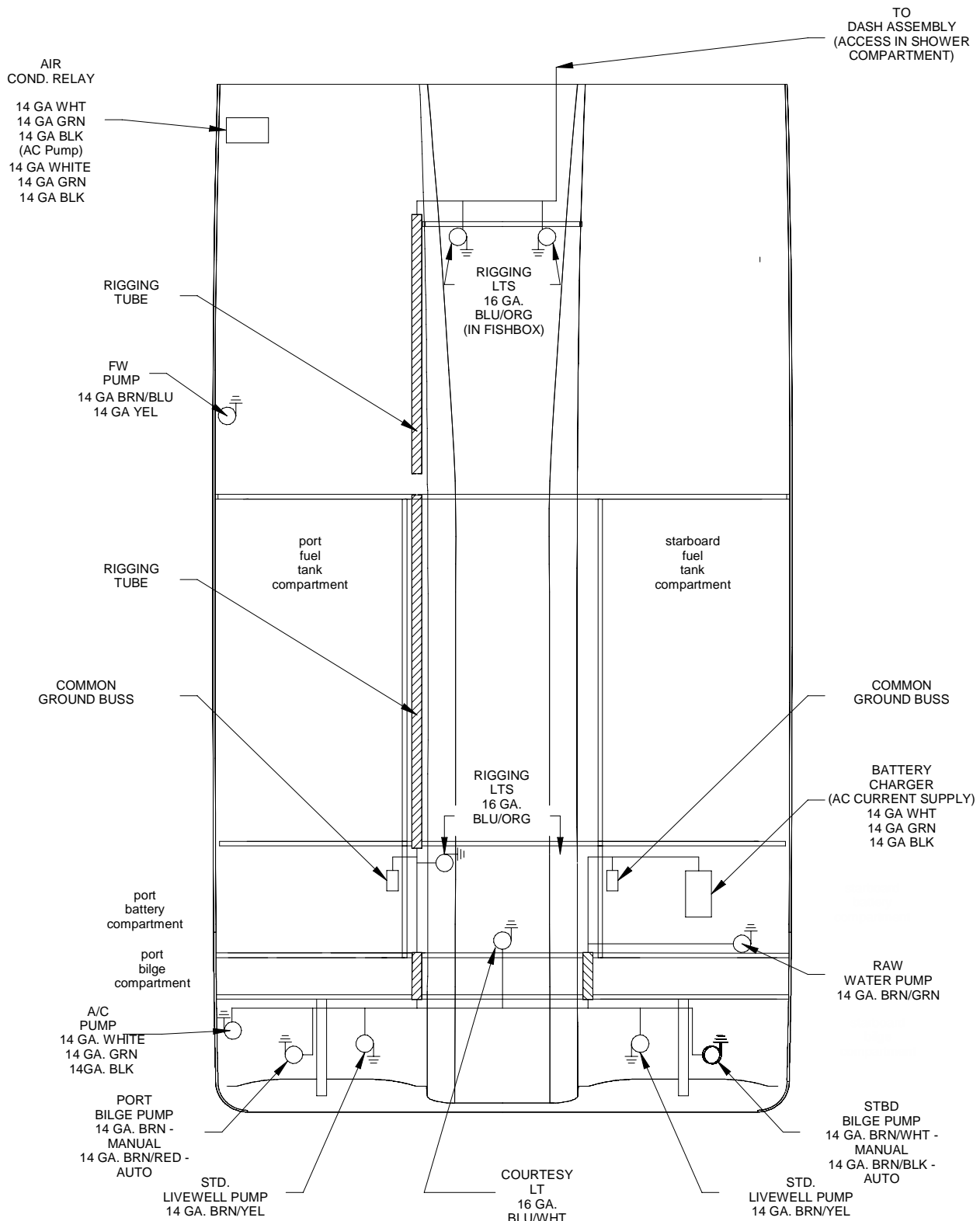

### 11.2.3 Forward Deck Wiring Diagram

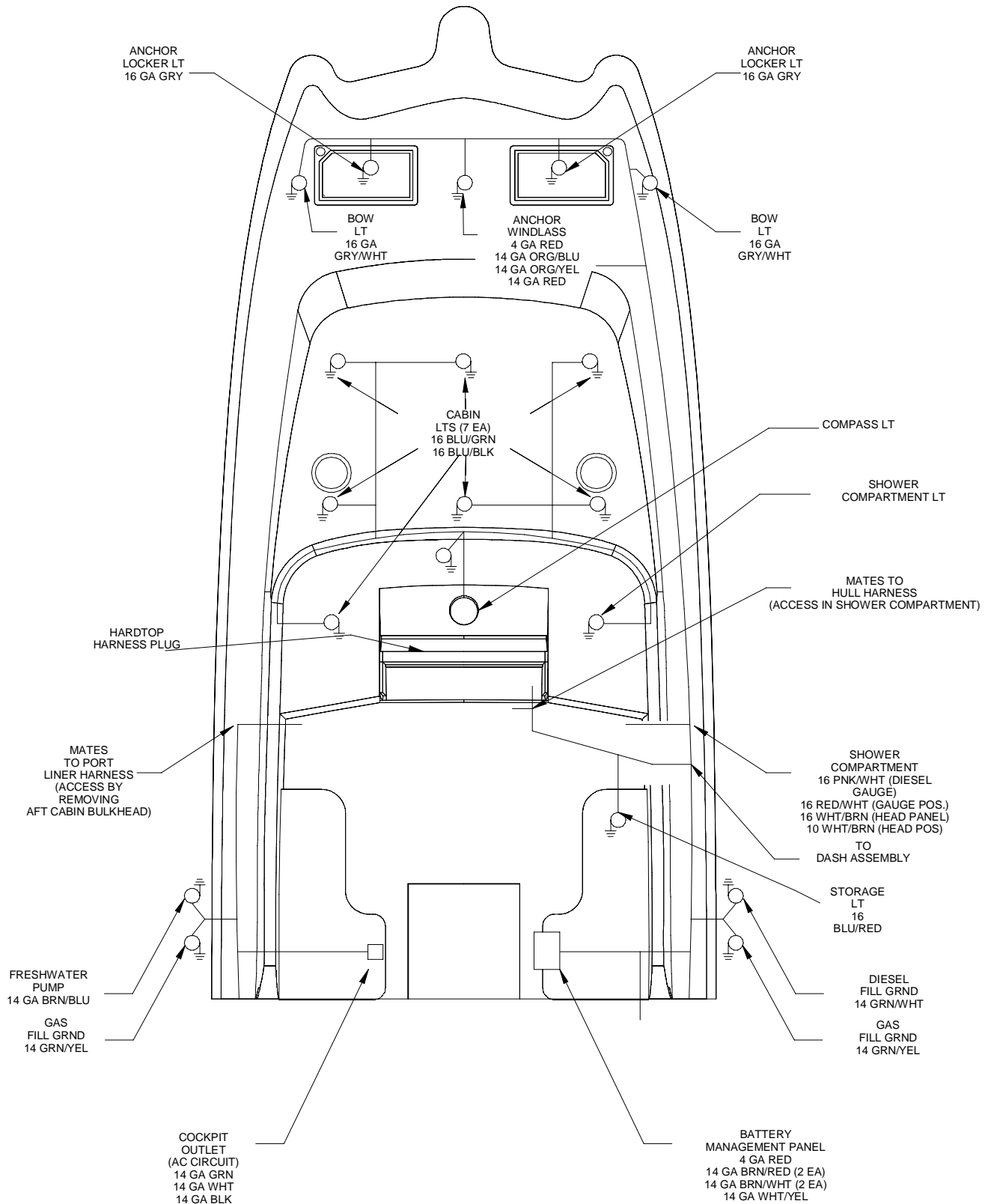

### 11.2.4 Aft Deck Wiring Diagram

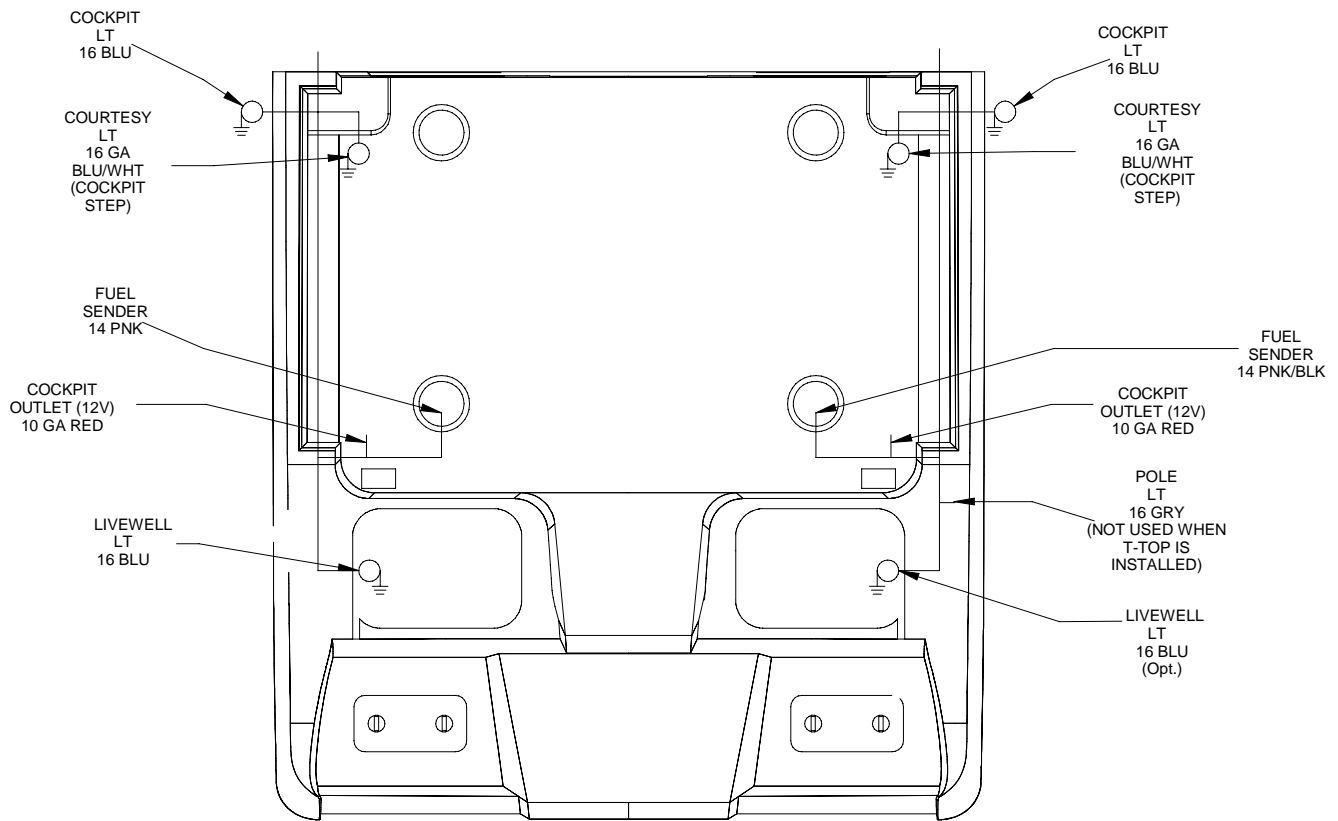

## 11.2.5 Cabin Wiring

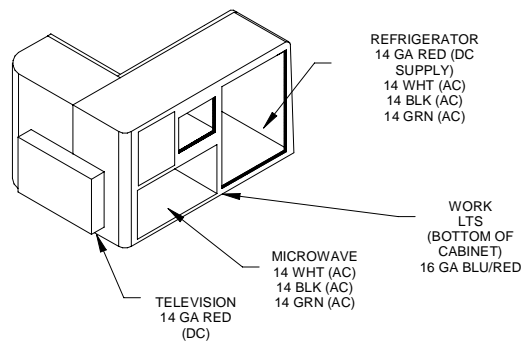
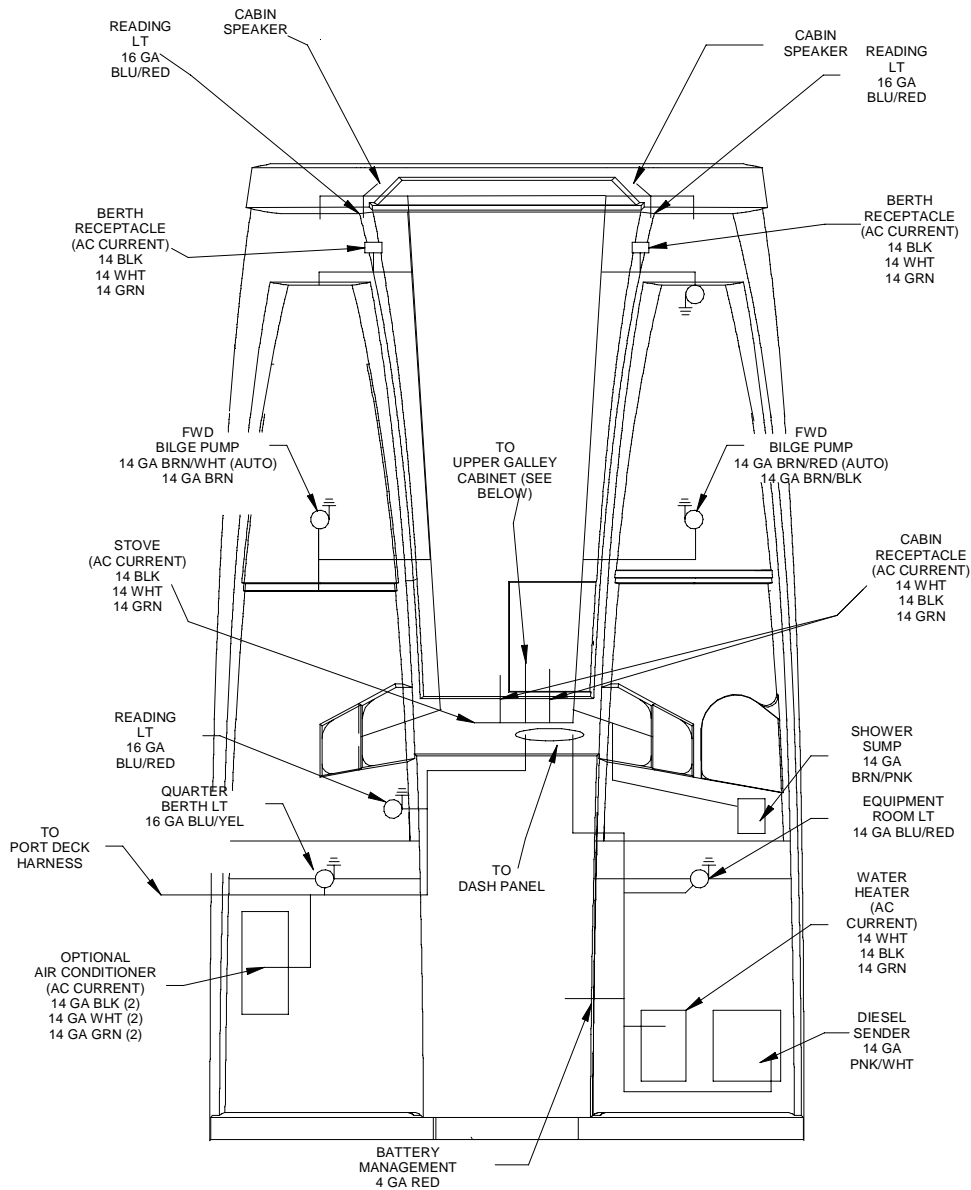

### 11.2.6 Battery Management System Diagram

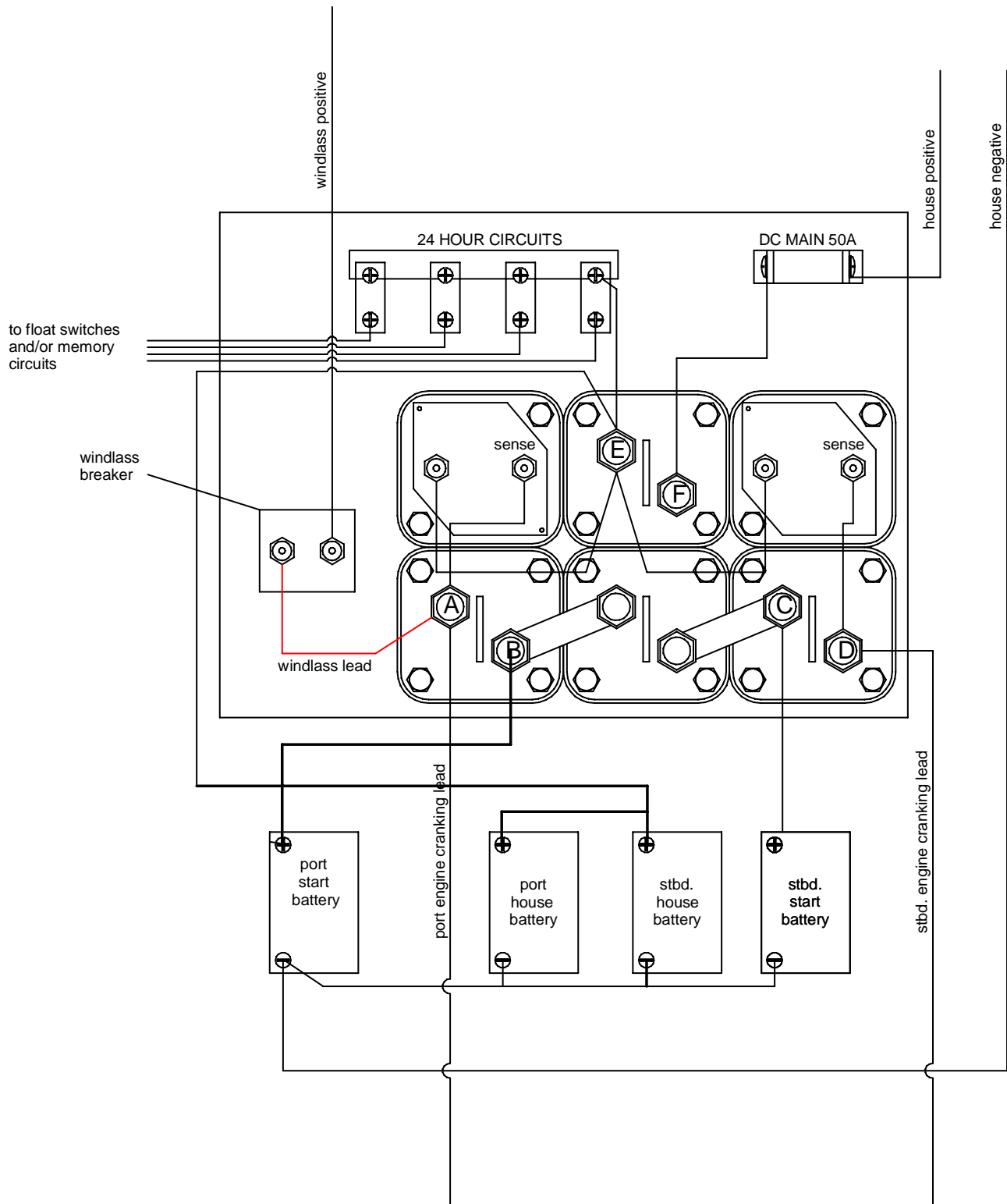

### 11.2.7 Freshwater System Diagram

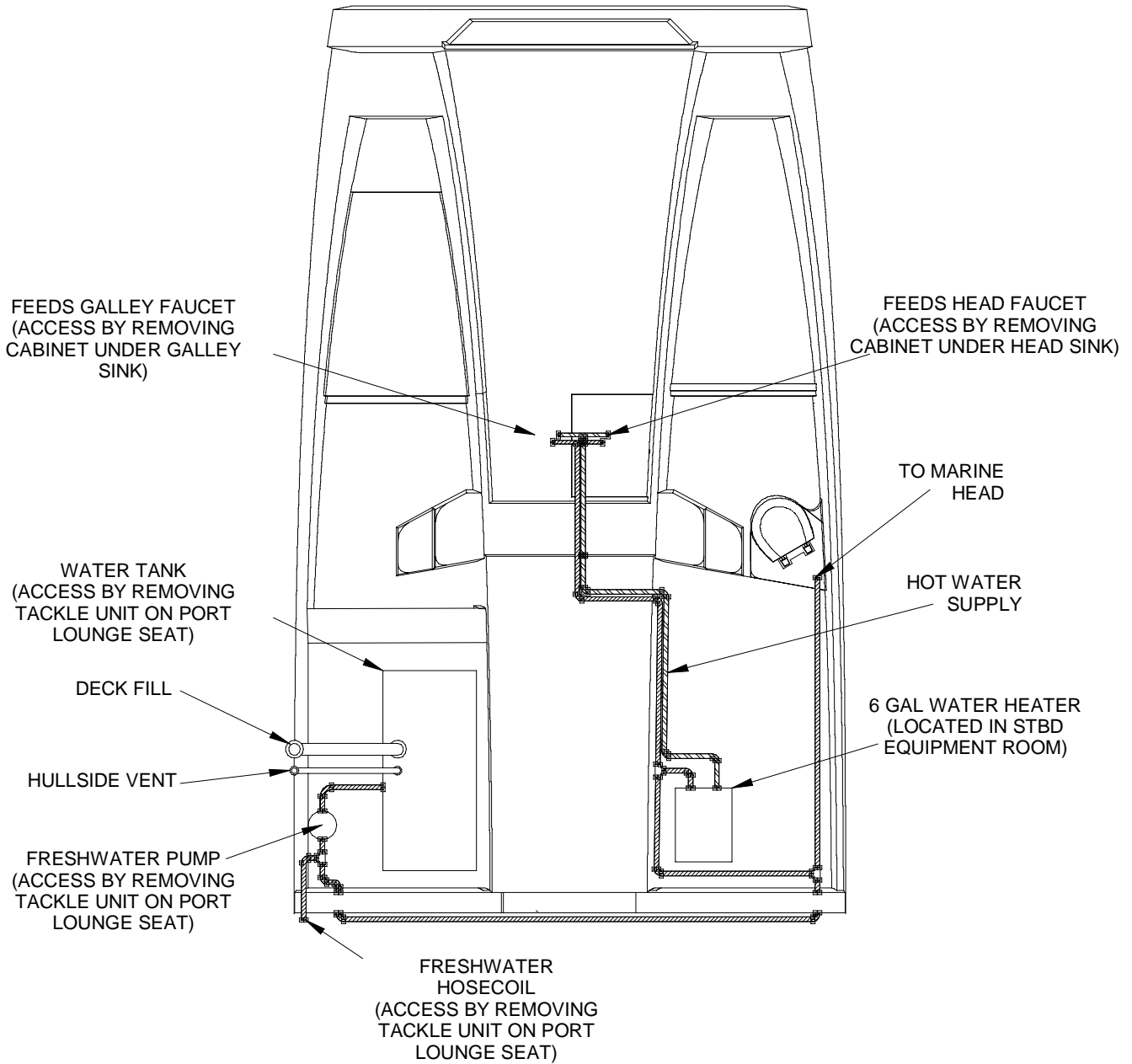

### 11.2.8 Livewell / Raw-water System

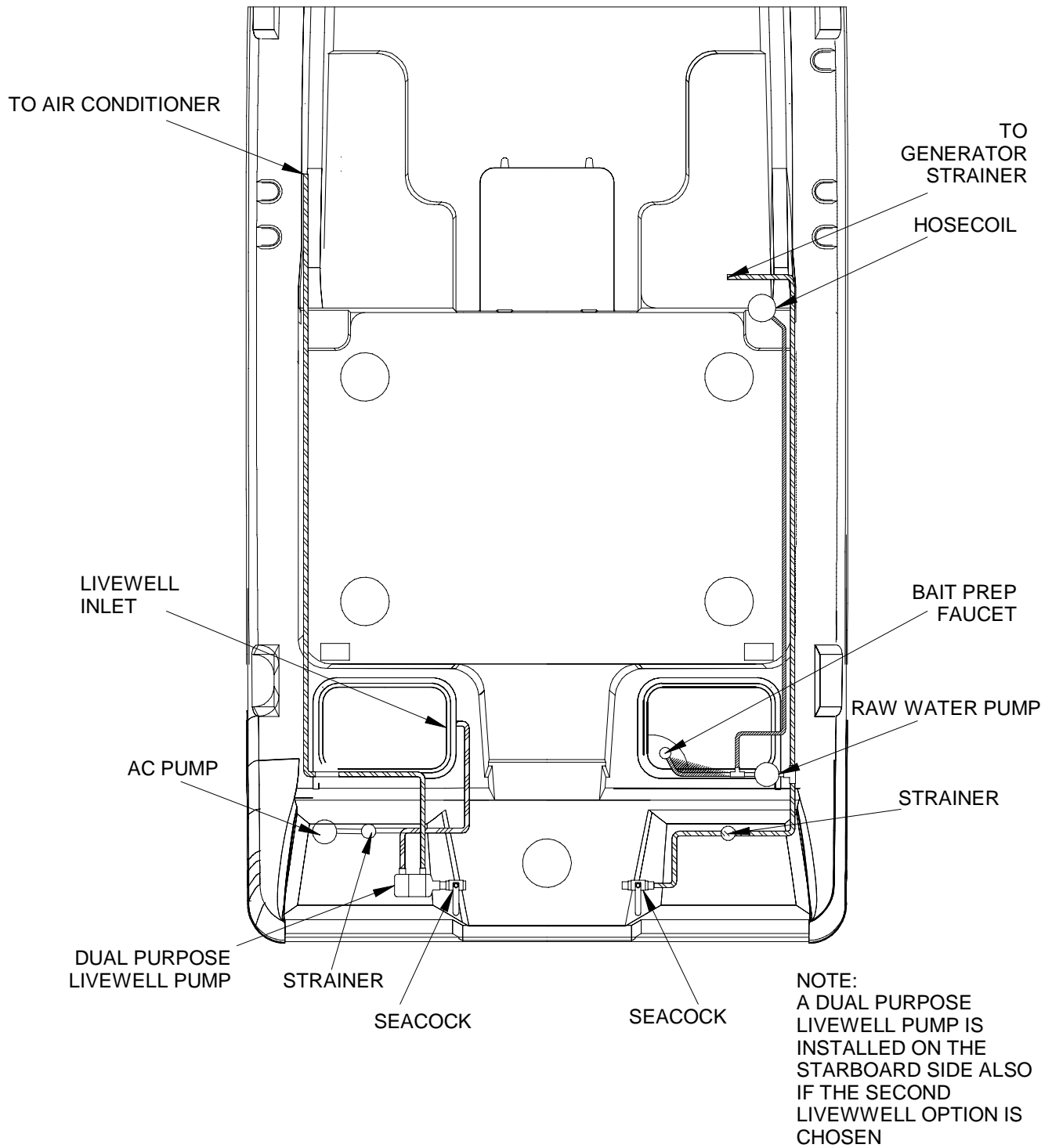

### 11.2.9 Marine Head Diagram

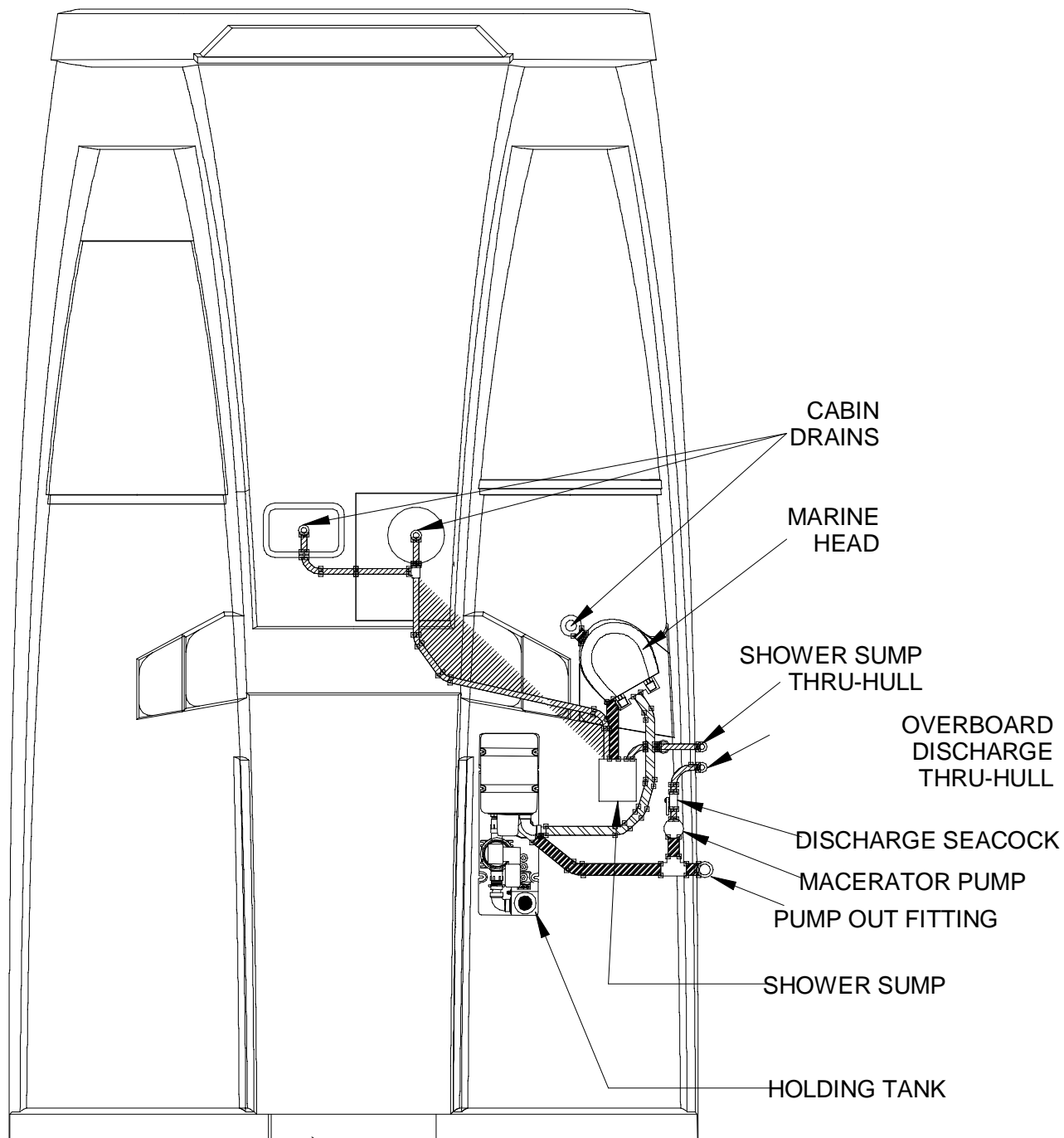



11.2.10 Thru-hull Diagram

T-HULL

A  
B  
C  
D  
E  
F  
G  
H  
I  
J  
K  
L  
M  
N  
O  
P  
Q  
R  
S

DESCRIPTION

AFT BILGE  
BAIT PREP SINK DRAIN  
SCUPPERS  
FUEL TANK VENT  
GENERATOR RELIEF  
FISHBOX DRAIN  
GENERATOR EXHAUST  
WATER HEATER RELIEF  
DIESEL TANK VENT  
HOLDING TANK VENT  
OVERBOARD DISCHARGE DRAIN  
SHOWER SUMP  
FWD BILGE  
ANCHOR LOCKER DRAIN  
ANCHOR LID DRAIN  
AIR CONDITIONER DRAIN  
COOLER DRAIN  
WATER TANK VENT  
LIVEWELL DRAIN

STERN

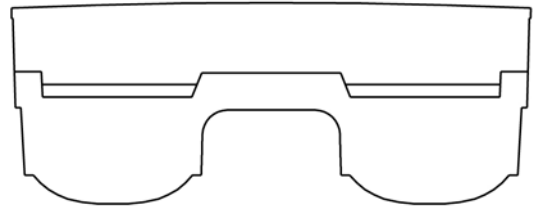

STARBOARD

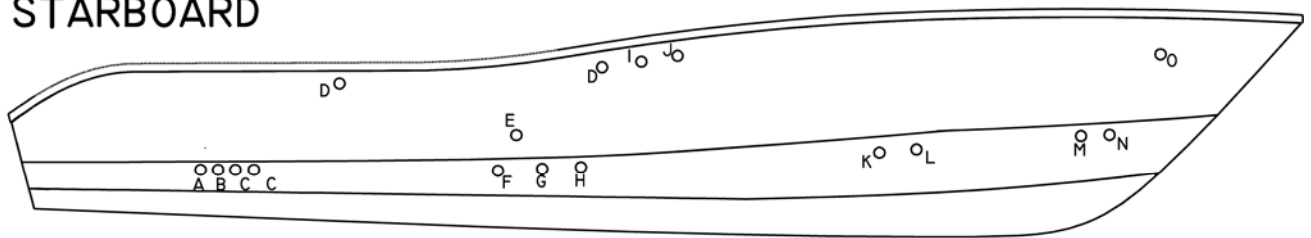

PORT

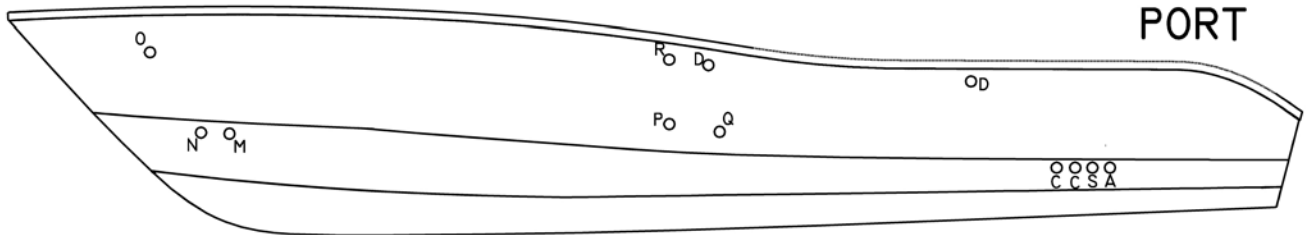









# 2015 320EC Spare Parts List

Service Class	Part Number	Description
Electrical & Lighting		
	20190123	12VDC Outlet for Downriggers
	20170274	12VDC Outlet for Lighter Plug
	20190139	12VDC Receptacle Mounting Plate
	20190138	12VDC Receptacle Plug Troll MTR, Plug Bulk
	20200364	2.75" LED Light (Red/Wht) w/Deutsch
	20170893	30A 125V Easy Lock Inlet SS Shore Power w/Enclosure
	20170893	30A 125V Easy Lock Inlet SS Shore Power w/Enclosure
	20190269	320EC AC Common Buss
	20192281	320EC AC -NT-V3 Panel Assy (110V/60HZ)
	20192281	320EC AC -NT-V3 Panel Assy (110V/60HZ)
	20190253	320EC Cockpit Receptacle









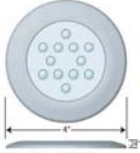

These parts should be installed by a certified World Cat dealer. Installation by a non-authorized 3rd party may result in improper enforcement and create safety concerns. Please contact your local, authorized, World Cat dealer to buy these parts at the same price.

**Price and availability subject to change.**

Service Class	Part Number	Description
	20190253	320EC Cockpit Receptacle
	20192212	320EC Dash Panel & Harness - New Style (2012)
	20156878	320EC Electronics Dash Panel (Black)
	20190267	320EC Galley Receptacle
	20190267	320EC Galley Receptacle
	20190268	320EC Head Receptacle
	20190268	320EC Head Receptacle
	20190257	320EC Port Berth Receptacle
	20190257	320EC Port Berth Receptacle
	20190258	320EC Stbd Berth Receptacle
	20190258	320EC Stbd Berth Receptacle

These parts should be installed by a certified World Cat dealer. Installation by a non-authorized 3rd party may result in improper enforcement and create safety concerns. Please contact your local, authorized, World Cat dealer to buy these parts at the same price.

**Price and availability subject to change.**

Service Class	Part Number	Description
	20200332	4" LED Light (Red/Wht)
	26500001	AC/DC Refrigerator (w/ black panel)
	20170902	Accessory Switch Assy
	20170956	Alarm-Co2 Carbon Monoxide
	20200297	Atwood LED Mast Light (24") - S/S Base
	20173462	Battery Mgmt Panel 320EC ( NEW)
	20156841	Battery Tray (Group 27) - Narrow Width - S/S Rods
	20150379	Battery Tray (Group 31) - Narrow Width - S/S Rods
	20170277	BEP Negative Buss Bar HD (300A/4-Pole)
	20190177	BEP Positive Stud
	20170922	Bilge Alarm System (2pcs)











These parts should be installed by a certified World Cat dealer. Installation by a non-authorized 3rd party may result in improper enforcement and create safety concerns. Please contact your local, authorized, World Cat dealer to buy these parts at the same price.

**Price and availability subject to change.**

Service Class	Part Number	Description
	20173489	Bluetooth Dongle - Sirius Input (Fusion Stereo)
	20170220	Cabin Light
		
	90440445	CmdLink 20' Main Bus
		
	20173417	Coastal Plus Wiper Motor 3 1/2" Shaft
		
	20151493	Day/Night (3" Rnd) White - w/Battery Backup Solar Mini-Vent
		
	20170335	Deka Battery (Group 31/Std)-House (DP31DT)
		
	20170360	Dual Direction Ctrl 12V (PM)
		
	26500514	Electric Cooktop Stove - 320EC (110V/60HZ)
		
	26500514	Electric Cooktop Stove - 320EC (110V/60HZ)
		
	20170941	F Right Angle 90 Degree 2.5GHz Adapter RG6 Audio Connector
		
	90440447	Faria Water Gauge (Generator)
		

These parts should be installed by a certified World Cat dealer. Installation by a non-authorized 3rd party may result in improper enforcement and create safety concerns. Please contact your local, authorized, World Cat dealer to buy these parts at the same price.

**Price and availability subject to change.**

Service Class	Part Number	Description
	20821092	Fischer Panda (NEW 2013) PMS4200 ECO Generator
	20173490	Fusion Marine 700 Series Internal Ipod ReceiverN2K (w/Amphenol Connector)
	20170361	Guarded Rocker Switch
	20170372	Hardtop Fuse Block
	20160464	LCD Flush Mounting Brkt
	20200283	LED Bow Lights (PR)
	20200272	LED Cockpit Light
	20200274	LED Cockpit Light Trim Ring
	20200274	LED Cockpit Light Trim Ring
	20200273	LED Livewell Light - Red
	20200273	LED Livewell Light - Red

These parts should be installed by a certified World Cat dealer. Installation by a non-authorized 3rd party may result in improper enforcement and create safety concerns. Please contact your local, authorized, World Cat dealer to buy these parts at the same price.

**Price and availability subject to change.**

Service Class	Part Number	Description
	20200291	LED Overhead Light (2.75")
	20200292	LED Overhead Light (4")
	20200301	LED Reading Light
	20170371	Lewmar ProFish 700 Windlass - Freefall
	20170874	Lewmar Windlass Up/Down Foot Switches (Black)
	20170882	Livewell Switch Bezel
	20200353	Lumitec Capri Flush-Mount LED Spreader Light
	26500501	Microwave-Current Model .7 CU 120v/60Hz, UL (Prefer Black)
	26500501	Microwave-Current Model .7 CU 120v/60Hz, UL (Prefer Black)
	20170341	OBS-400Watt Inverter 12 Volt
	26500250	Outlet Box

These parts should be installed by a certified World Cat dealer. Installation by a non-authorized 3rd party may result in improper enforcement and create safety concerns. Please contact your local, authorized, World Cat dealer to buy these parts at the same price.

**Price and availability subject to change.**

Service Class	Part Number	Description
	20173457	Panel ELCI 120V 30A 2P 30mA Toggle Breaker
	20200286	Pole Light Base, Black SS w/ Locking Collar (2-Pin Light)
	20173375	ProSafe Galvanic Isolator (30A)
	20170925	ProSafe Galvanic Isolator (60A)
	20170925	ProSafe Galvanic Isolator (60A)
	20173445	ProSport 20 PFC 3-Bank Waterproof Charger (20A, 50/60Hz 90-240VAC) (International)
	20173426	ProSport 20 Plus 3-Bank Waterproof Charger (20A, 50/60Hz 90-135VAC)
	20173426	ProSport 20 Plus 3-Bank Waterproof Charger (20A, 50/60Hz 90-135VAC)
	20170943	Ritchie Compass (Large Profile)
	20170913	Ritchie Compass (Small Profile)
	20200245	Rope Lighting

These parts should be installed by a certified World Cat dealer. Installation by a non-authorized 3rd party may result in improper performance and create safety concerns. Please contact your local, authorized, World Cat dealer to buy these parts at the same price.

**Price and availability subject to change.**



Service Class	Part Number	Description
	20173465	Skyworth 15.6" AC/DC 720p LCD TV/DVD Combo
	20173431	Sony AM/FM Antenna w/ Amp
	W7010034	Tankwatch Panel for 320EC Holding Tank (Dometic)
	20200359	Vimar 3M Faceplate (Chrome)
	20200361	Vimar Mounting Frame 2M
	20200360	Vimar Mounting Frame 3M
	20200356	Vimar On - Off Switch
	26500252	Weatherproof Cover Plate
	20170871	Windlass Breaker 50A
	20190316	Windlass Hot Lead 4AWG (1/4 -3/8) 1' (CUSTOM)
	20170314	Wiper Blade (22") - 32EC

These parts should be installed by a certified World Cat dealer. Installation by a non-authorized 3rd party may result in improper enforcement and create safety concerns. Please contact your local, authorized, World Cat dealer to buy these parts at the same price.

**Price and availability subject to change.**

Service Class	Part Number	Description
---------------	-------------	-------------



20170911 Wiper Controls Backing Plate



20170880 Wiper Fluid Reservoir (4 liter)

**Fiberglass**



20130006 Laminated Anchor Locker Lid (230SF,250SF/DC,290,320)



26003465 Laminated Dash - New Style (320EC) (2012)



26000226 Laminated Deck Cap-Port Only (320EC)

26000227 Laminated Deck Cap-Stbd Only (320EC)



26000219 Laminated Fishbox Lid Only (320EC)



26000299 Laminated Generator Access Lid: 320EC

26000186 Laminated Livewell Lid (320EC/330TE)



26000217 Laminated Seatbox Lid-Port (320EC)



26000218 Laminated Seatbox Lid-Stbd (320EC)







These parts should be installed by a certified World Cat dealer. Installation by a non-authorized 3rd party may result in improper enforcement and create safety concerns. Please contact your local, authorized, World Cat dealer to buy these parts at the same price.

**Price and availability subject to change.**



Service Class	Part Number	Description
	26000251	Laminated WC White Swim Platform Floor
<b>Fuel System</b>		
	20160511	1 1/2" Diesel Fill
	20180013	1/4 PT X 3/8 HB, Brass
	20160328	1/4 PT X 3/8 HB, Brass 90 deg.
	20160334	1/4" Male PT x 5/16" HB
	20160340	AL 130GA Gas Tank Strap
	20220083	Attwood FDV Fuel Demand Value (No-Antisiphon)
	20163465	Attwood Inlet Control Valve (EPA Diurnal)
	20163488	Attwood Pressure Relief Deck Gas Fill (Straight Zamak/Chrome)
	20220029	Diesel Generator Tank 10 Gal (EC's)
	90440446	Faria Fuel Gauge (Generator)

These parts should be installed by a certified World Cat dealer. Installation by a non-authorized 3rd party may result in improper enforcement and create safety concerns. Please contact your local, authorized, World Cat dealer to buy these parts at the same price.

**Price and availability subject to change.**

Service Class	Part Number	Description
	20140102	Fuel Hose 1 1/2" (50'/RL)
	20140103	Fuel Hose 3/8" (250'/RL)
	20140104	Fuel Hose 5/8" (250'/RL)
	20160504	Fuel Tank Vent 90 deg - Flush Mount 5/8"
	20821091	Racor Fuel Filter (Generator)
	90441543	Yamaha Fuel Filter/Water Seperator

**Gel coat**

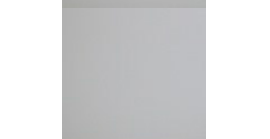
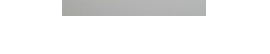
	20040120	Gel Ext Ashland "Aqua Mist" (Awlgrip H4365 Match) (16052913) (DR838)
	20040132	Gel Ext Ashland "Platinum" (RAL-7040 Window Gray) (16052917) (DR838)
	20040037	Gel Ext Ashland "World Cat Exterior" (164922)
	20040037	Gel Ext Ashland "World Cat Exterior" (164922)
	20040098	Gel Ext Ashland NCP "Sapphire Blue" (RAL-5003) (16052915) (DR838)

These parts should be installed by a certified World Cat dealer. Installation by a non-authorized 3rd party may result in improper enforcement and create safety concerns. Please contact your local, authorized, World Cat dealer to buy these parts at the same price.

**Price and availability subject to change.**

Service Class	Part Number	Description
---------------	-------------	-------------

20040128	Gel Ext Ashland NRP "Ice Blue" (Sea Hunt Match) (16052912) (DR838)
----------	--

20040128	Gel Ext Ashland NRP "Ice Blue" (Sea Hunt Match) (16052912) (DR838)
----------	--

20040090	Gel Int Ashland "SR Arctic White" Gel (11 Series)
----------	---

20040090	Gel Int Ashland "SR Arctic White" Gel (11 Series)
----------	---

Graphic & Logos
-----------------



20150199	Decal- Boot Stripe (Die Cut Pattern)
----------	--------------------------------------

20690222	Decals for Graphic Package (All models available)
----------	---

20690318	Decal-Stripping for Boot Stripe Option
----------	--

20690342	Model Designator - 320EC (2008)
----------	---------------------------------



20600229	NMMA Yacht Plate (World Cat)
----------	------------------------------







20690484	PowerCat Group RTM Coverup (Crystal Cap Foam Backed, 1.5 x 2.25)
----------	--



20690345	Vectorflo Graphic
----------	-------------------

These parts should be installed by a certified World Cat dealer. Installation by a non-authorized 3rd party may result in improper enforcement and create safety concerns. Please contact your local, authorized, World Cat dealer to buy these parts at the same price.

**Price and availability subject to change.**

Service Class	Part Number	Description
	60690302	Warning Label - Prop Helm
	60690301	Warning Label - Prop Transom
	20150036	WCC Main Decal Strip Roll
	20690331	World Cat "S/S" Hullside Logo (Chrome 3.15" x 26")

**Hardware- Deck**



20160486 1 1/2" Painted Cap

26500465 12" Dia Round Hatch Screen for N1115

26500463 12" Dia Round Hatch Trim Ring (Off White) for N1115



26500461 12" Dia Round Hatch, Clear Anodized, Tempered Glass (Hatch Only)



20150232 12" Handrail W/ Studs, S/S Part

26500466 20" Dia Round Hatch Screen for N1139

26500464 20" Dia Round Hatch Trim Ring (Off White) for N1139











These parts should be installed by a certified World Cat dealer. Installation by a non-authorized 3rd party may result in improper enforcement and create safety concerns. Please contact your local, authorized, World Cat dealer to buy these parts at the same price.

**Price and availability subject to change.**

Service Class	Part Number	Description
	26500462	20" Dia Round Hatch, Clear Anodized, Tempered Glass (Hatch Only)
	20700279	24" Folddown Stern Seat Frame (290's/320EC)
	20610396	255/270/320 World Cat Aft Pre-Bent (Port) - Taco CRB/304 SS
	20610397	255/270/320 World Cat Aft Pre-Bent (Stbd) - Taco CRB/304 SS
	20160516	290EC/320EC Shower Sump Grate
	20160229	3" Cable Boot, Off White
	20160329	3" White Trim Ring (Chaffing Ring)
	20160231	3/8" Plastic Drain
	W7010070	320EC - Front Stbd Windshield Panel Frame/Glass
	W7010085	320EC - Port Windshield "Wing" Panel Frame/Glass
	W7010084	320EC - Stbd Windshield "Wing" Panel Frame/Glass

These parts should be installed by a certified World Cat dealer. Installation by a non-authorized 3rd party may result in improper enforcement and create safety concerns. Please contact your local, authorized, World Cat dealer to buy these parts at the same price.

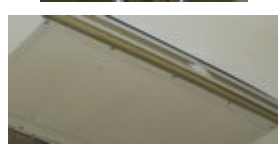





**Price and availability subject to change.**

Service Class	Part Number	Description
	20310236	320EC Cabin Windshield w/ Fixed Center (Clear AL)
	20510308	320EC E-Stand Pipe for Top
	26500483	320EC Forward Drawer Assy - Matte Wild Cherry
	26500484	320EC Galley Cabinet A - Matte Wild Cherry
	26500485	320EC Galley Cabinet B - Matte Wild Cherry
	26500486	320EC Galley Drawer Assembly - Matte Wild Cherry
	20163479	320EC Hardtop Electronics Access (1/4" Acrylic)
	20510325	320EC Hardtop Frame for Upper Station (Silver Launchers) (2008)
	20510933	320EC Lifejacket Storage Canvas (Tan)
	26500487	320EC Port Berth Extension - Matte Wild Cherry
	20150924	320EC Starboard Shelf Trim

These parts should be installed by a certified World Cat dealer. Installation by a non-authorized 3rd party may result in improper enforcement and create safety concerns. Please contact your local, authorized, World Cat dealer to buy these parts at the same price.

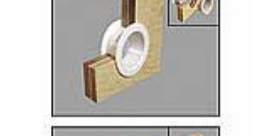
**Price and availability subject to change.**



Service Class	Part Number	Description
	26500488	320EC Stbd Berth Extension - Matte Wild Cherry
	26500489	320EC Teak/Holly Galley Floor - Matte Finish
	26500490	320EC Teak/Holly Port Floor - Matte Finish
	26500491	320EC Teak/Holly Stbd Floor - Matte Finish
	W7013392	330TE/320EC V-Beth Door Lock
	20160330	4" White Trim Ring (Chaffing Ring)
	20160330	4" White Trim Ring (Chaffing Ring)
	20160018	4" x 1.5" 330TE Tran Door Hinge
	20150885	4" x 10" Almond Plastic Floor Register
	20163444	4.5" Cable Boot - Black
	20160241	5" Straight Chock for Pulpit

These parts should be installed by a certified World Cat dealer. Installation by a non-authorized 3rd party may result in improper enforcement and create safety concerns. Please contact your local, authorized, World Cat dealer to buy these parts at the same price.

**Price and availability subject to change.**

Service Class	Part Number	Description
	20150233	7" Handrail w/ Studs, S/S Part
	20163550	8" Cutting Edge sleek pull up cleat
	20160563	Adjustable Windshield Brace (14 1/2"-16 1/2")
	20210267	Aluminum Cushioned Clamps (1")
	20210266	Aluminum Cushioned Clamps (3/4")
	20150333	Anchor Rode Special 8-Plaited Anchor Rope (2005)
	20150332	Anchor Safety Strap (2005)
	20160322	Armstrong 8" Watertight Access Plate - Off White (WC)
	20160323	Armstrong Square Motorwell Plate (10" x 20" Rect) - Off White WC
	20163486	ASI Bracket for Gas Shocks
	20163485	ASI S/S Flat Bracket for Gas Shocks w/10MM

These parts should be installed by a certified World Cat dealer. Installation by a non-authorized 3rd party may result in improper enforcement and create safety concerns. Please contact your local, authorized, World Cat dealer to buy these parts at the same price.

**Price and availability subject to change.**

Service Class	Part Number	Description
	W7010057	Bottom H Section of Seat (290's/320EC-24" Folddown Stern Seat)
	20150235	Bow Roller
	26500265	Cabin Entry Door 320EC Port
	26500266	Cabin Entry Door 320EC Stbd
	20170217	Cabin Portlight w/ S/S Ring
	20140107	Clear Hose 3/8" (200'/RL)
	20600241	Color Match 304SS & Vinyl Bow (WC 320)
	26500316	Cutting Board With Cleats (320EC)
	26500316	Cutting Board With Cleats (320EC)
	26500289	Door, Head - 320EC
	20160169	Drain Plate Stainless Steel Cockpit Area

These parts should be installed by a certified World Cat dealer. Installation by a non-authorized 3rd party may result in improper performance and create safety concerns. Please contact your local, authorized, World Cat dealer to buy these parts at the same price.

**Price and availability subject to change.**

Service Class	Part Number	Description
	20430001	Draw Latch (Small Rubber 4.16")
	20160477	Draw Latch Keeper
	26500324	Drawer Assembly, Head (2006) (290DC, 290CC, 320CC, 320EC, 330TE)
	20161421	Flexible Rub Rail - White 250'
	20163466	Gas Shock 12" Ext. Length, 30lb, 316SS w/ Composite End
	20163469	Gas Shock 17" Ext. Length, 30lb, 316SS w/ Composite Ends
	20160275	GEM S/S Lift Handle Latch Lock 3"
	26500329	Head Instrument Enclosure- 320EC (2006)
	20160703	Hinge 2" x 3" Anchor Lid Style
	20160363	Holder Magnetic Window 316SS 30 x 15 Strike
	20163472	IPS 4" Access Plate (Dream White - World Cat)











These parts should be installed by a certified World Cat dealer. Installation by a non-authorized 3rd party may result in improper enforcement and create safety concerns. Please contact your local, authorized, World Cat dealer to buy these parts at the same price.

**Price and availability subject to change.**

Service Class	Part Number	Description
	20163473	IPS 6" Access Plate (Dream White - World Cat)
	20163474	IPS 8" Access Plate (Dream White - World Cat)
	20150311	Large Anchor 22lb
	20160016	Latch Cam for 250DC/23DC
	20163461	Lewmar Pilot Hatch SZ-78 (32" x 32")
	20160465	Lid Lock Spacer 2"-Black
	20160357	Magnetic Door Holder (Proud/Flush)
	20500273	Mesh Carrying Bag For A Pair Of Outriggers
	26500278	Mirror 2770/320 Cabin 14 x 40 x 1/4
	26500438	Mirror Holder 4pc Kit w/ Screws & Anchors Hillman Number
	20160124	Neoprene .25" thick Gasket Material Cut in 2" sections (10FT/EA)

These parts should be installed by a certified World Cat dealer. Installation by a non-authorized 3rd party may result in improper enforcement and create safety concerns. Please contact your local, authorized, World Cat dealer to buy these parts at the same price.

**Price and availability subject to change.**

Service Class	Part Number	Description
	28130284	Outrigger Backing Plates (2/SET)
	28130278	Pair of Taco Outrigger Poles 18' Silver w/ Gold
	20160488	Pedestal Base Inserts (Seafoam HDPE) Rev-1
	20160121	Piano Hinge (1.75"W/050) - 11.5"
	26500361	Port Countertop - 320EC (2008)
	26500313	Port Toe Rail (320EC)
	20163542	Push to Close Latch, Slide (Non-Magnet)
	20150363	Revolving Lock For Rod Hanger
	20160343	Rigging 2" Flange w/ Fuel Hose Port-Black
	20160344	Rigging Flange Hose Union (Black)
	20140123	Rigging Hose-Black 2" (50'/RL)











These parts should be installed by a certified World Cat dealer. Installation by a non-authorized 3rd party may result in improper enforcement and create safety concerns. Please contact your local, authorized, World Cat dealer to buy these parts at the same price.

**Price and availability subject to change.**

Service Class	Part Number	Description
	20140123	Rigging Hose-Black 2" (50'/RL)
	20500274	Rigging Kit Premium Black Cord Trip Ese
	20150259	Rod Holder Grommet (3 3/8")
	26500308	Rod Holder Port - 320EC
	26500309	Rod Holder Starboard - 320EC
	20150252	Rub Rail Insert - Bendable 304 S/S (16' EA)
	20610259	Rub Rail Off-White (20ft) (World Cat)
	20156871	S/S 2-Step Cup Holder w/ Drain (92mm)
	20163391	S/S 30° Rod Holder (Cast Head, Formed Tube w/ Drain)
	60233231	Safety Walk 12" x 60' Black (60FT/RL) 60sqft fer roll
	20160044	Screen for Portlight

These parts should be installed by a certified World Cat dealer. Installation by a non-authorized 3rd party may result in improper enforcement and create safety concerns. Please contact your local, authorized, World Cat dealer to buy these parts at the same price.

**Price and availability subject to change.**

Service Class	Part Number	Description
	20150290	Small Hatch w/ Offset (Battery Mgmt Door)
	20170254	Stainless FIAM Horn
	20150292	Starboard Large Hatch (14x23) (290DC, 290CC, 320CC, 320EC, 330TE)
	20150291	Starboard Small Hatch (11 3/16 x 14 3/4)
	20150364	Stationary Holder for Rod Hanger
	26500362	Stbd Countertop - 320EC (2008)
	26500314	Stbd Toe Rail (320EC)
	20150152	Tackle Box (LRG)
	20160236	Thru Hull Plastic 90 1 1/2"
	20160237	Thru Hull Plastic 90 3/4"
	20150011	Transom End Cap, Nylon, Offwhite (World Cat)

These parts should be installed by a certified World Cat dealer. Installation by a non-authorized 3rd party may result in improper enforcement and create safety concerns. Please contact your local, authorized, World Cat dealer to buy these parts at the same price.

**Price and availability subject to change.**



Service Class	Part Number	Description
---------------	-------------	-------------

\*\*20610386 Transom Molding (Arctic White) 12' EA Thinner / No Holes

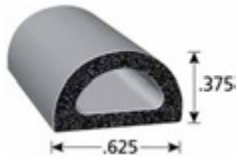

20160352 Trim-Lok X-109BT (Lids)

20500889 Upper Station Rigging Tube (Angle)



20500890 Upper Station Rigging Tube (Straight)



W7013413 Velcro Straps for WMW Swim Ladder.



20161420 White Rubrail Insert (250FT Spools EA)

**Hardware- Hull**

20690226 290/320/330 Bow Eye / 330 Stern Eye (5/8" x 4 5/8")



20160242 8" Cleat



20160351 Bow Eye 304SS 5/8" x 6" GLO, SS



20150225 Drain Plug (Garboard)







20820436 Fischer Panda Motor Mounts S/S P4 (Order as 4/PK)





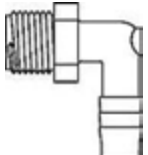

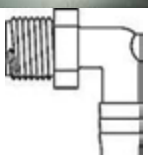
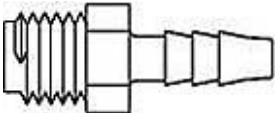
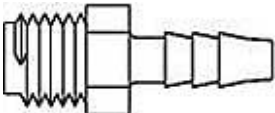
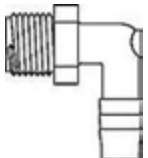
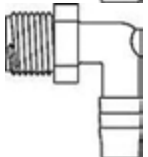





These parts should be installed by a certified World Cat dealer. Installation by a non-authorized 3rd party may result in improper performance and create safety concerns. Please contact your local, authorized, World Cat dealer to buy these parts at the same price.

**Price and availability subject to change.**

Service Class	Part Number	Description
	26500315	Pulpit Trim Cover (320EC/CC)
	20160383	Transom Motor Plate (Lower)
	20161423	Transom Motor Plate (Upper) - No Branding
<b>Plumbing</b>		
	20160084	1 1/2" PT x 1 1/2" HB, EL112
	20160512	1 1/2" Waste Pump Out
	20160510	1 1/2" Water Fill
	20160087	1/2 PT X 3/4 HB "L",PVC Elbow 1234
	20160086	1/2 PT X 3/4 HB STR.,PVC A1234
	20160086	1/2 PT X 3/4 HB STR.,PVC A1234
	20160093	1/2 PT X 3/8 HB "L", EL1238
	20160089	1/2 PT X 5/8 HB "L", PVC

These parts should be installed by a certified World Cat dealer. Installation by a non-authorized 3rd party may result in improper enforcement and create safety concerns. Please contact your local, authorized, World Cat dealer to buy these parts at the same price.

**Price and availability subject to change.**

Service Class	Part Number	Description
	20160366	1/4" MPT x 5/16" HB (90 DEG)
	20740253	120VAC Pump for AC
	20740253	120VAC Pump for AC
	20160466	3 Way Reducing Tee (1 1/8" x 3/4" x 1 1/8")
	20160092	3/4 PT X 3/4 HB, PVC, A34
	20160039	3/4 x 3/4 HB Tee
	20530463	3/4" Blue Check Valve
	20160127	3/4" Brass Intake w/ Nut Hi-Speed Water Pick up Bronze
	20160518	3/4" Bulkhead Thru Hull
	20160350	3/4" Male PT to 1" HB
	20160378	500GPH Bilge Pump Bracket

These parts should be installed by a certified World Cat dealer. Installation by a non-authorized 3rd party may result in improper performance and create safety concerns. Please contact your local, authorized, World Cat dealer to buy these parts at the same price.

**Price and availability subject to change.**

Service Class	Part Number	Description
	20160547	Automatic Float Switch Mounting Brkt
	20160560	Ball Valve, Brass, 3/4"
	20160388	Barbed 1-1/8" 90 Degree Aerator Head - Livewell Inlet w/ Shutoff Black
	20160388	Barbed 1-1/8" 90 Degree Aerator Head - Livewell Inlet w/ Shutoff Black
	20140100	Bilge Hose 1 1/2" (100'/RL)
	20140099	Bilge Hose 1 1/8" (100'/RL)
	20140098	Bilge Hose 3/4" (100'/RL)
	W7010033	Bleeder Nipple-Teleflex Power Steering Pump
	W7010033	Bleeder Nipple-Teleflex Power Steering Pump
	20160532	Bronze Low-Volume Water Pickup (Notched)
	20160556	Deck Fill Key

These parts should be installed by a certified World Cat dealer. Installation by a non-authorized 3rd party may result in improper performance and create safety concerns. Please contact your local, authorized, World Cat dealer to buy these parts at the same price.

**Price and availability subject to change.**

Service Class	Part Number	Description
	20160339	Drain, Head 320EC
	20160349	Elbow 3/8" Compression Fitting to 1/4" Male Pipe Thread
	20160094	Elbow, Faucet 3/4 HB X 1/2 FPT
	26500270	Faucet-Galley 320Cabin
	26500274	Faucet-Head 320Cabin
	20820440	Headhunter Inlet Strainer (3/4")
	W7013314	Impeller Kit for Shurflo Macerator Pump
	20530464	Livewell Hose 1 1/8" Black HD PVC (100'/RL)
	20160392	Livewell Overflow Drain (Threaded Internal 1 1/2" 90)
	20160392	Livewell Overflow Drain (Threaded Internal 1 1/2" 90)
	20740248	Macerator Pump w/ Deutsch Plug

These parts should be installed by a certified World Cat dealer. Installation by a non-authorized 3rd party may result in improper performance and create safety concerns. Please contact your local, authorized, World Cat dealer to buy these parts at the same price.

**Price and availability subject to change.**

Service Class	Part Number	Description
	20160267	Nylon Elbow 3/4" Male PT x 3/4" HB
	20161489	Nylon Female Adapter 1/2" FPTx 3/4" HB
	20161489	Nylon Female Adapter 1/2" FPTx 3/4" HB
	20140011	Reinforced Hose 3/8" (250'/RL)
	20160221	Rubber Stopper (1 1/8") PP1118
	20740299	Rule-A-Matic Float Switch w/ Deutsch Plug
	20740250	Rule-Mate Bilge Pump w/ Deutsch (500 GPH)
	20740298	Rule-Non Automatic Bilge pump w/ Deutsch (1500 GPH)
	20140128	Sanitation Hose 1" (100'/RL)
	20140127	Sanitation Hose 1.5" (100'/RL)
	26500302	Scandvik Euro Sprayer

These parts should be installed by a certified World Cat dealer. Installation by a non-authorized 3rd party may result in improper enforcement and create safety concerns. Please contact your local, authorized, World Cat dealer to buy these parts at the same price.

**Price and availability subject to change.**

Service Class	Part Number	Description
	26500302	Scandvik Euro Sprayer
	26500275	Scandvik Euro Sprayer Bracket
	20740246	ShurFlo Livewell Pump w/ Deutsch (1100 GPH)
	20740246	ShurFlo Livewell Pump w/ Deutsch (1100 GPH)
	20740303	ShurFlo Pro Blaster 2 Water Pump
	60233362	Sika White #292i-W High Strength Adhesive Sealer
	20820852	Strainer Mounting Bracket
	20161462	Swivel Nut Water Strainer for Washdown Pumps
	W7010092	Tankmaster 4 Automatic Discharge Pump Controller TM4-12 W/O SC Lite
	20160359	Tee Insert Poly 1"
	20160224	Thru Hull Plastic 1 1/2" w/ Scupper White

These parts should be installed by a certified World Cat dealer. Installation by a non-authorized 3rd party may result in improper performance and create safety concerns. Please contact your local, authorized, World Cat dealer to buy these parts at the same price.

**Price and availability subject to change.**

Service Class	Part Number	Description
	20160218	Thru Hull Plastic 1 1/8"
	20160517	Thru Hull Plastic 1"
	20160295	Thru Hull Plastic 2" w/ Scupper
	20160217	Thru Hull Plastic 3/4"
	20160219	Thru Hull Plastic 90 1 1/8"
	20163451	Thru-Hull, Resin 90° w/SS Cover, 1"
	20163453	Thru-Hull, Resin 90° w/SS Cover, 1-1/2"
	20163453	Thru-Hull, Resin 90° w/SS Cover, 1-1/2"
	20163452	Thru-Hull, Resin 90° w/SS Cover, 1-1/8"
	20163452	Thru-Hull, Resin 90° w/SS Cover, 1-1/8"
	20163450	Thru-Hull, Resin 90° w/SS Cover, 3/4"

These parts should be installed by a certified World Cat dealer. Installation by a non-authorized 3rd party may result in improper enforcement and create safety concerns. Please contact your local, authorized, World Cat dealer to buy these parts at the same price.









**Price and availability subject to change.**





Service Class	Part Number	Description
	20163456	Thru-Hull, Resin w/SS Cover, 1-1/2"
	20163456	Thru-Hull, Resin w/SS Cover, 1-1/2"
	20163455	Thru-Hull, Resin w/SS Cover, 1-1/8" - 1-1/4"
	20163454	Thru-Hull, Resin w/SS Cover, 3/4"
	20163457	Thru-Transom Scupper, Resin, w/ SS Cover, 1-1/2" (4-3/8")
	26500343	Toilet Poly Spacer (320EC)
	26500268	VacuFlush Waste Tank System
	20160220	Vinyl Push Plug (1-1/2") Black
	20160220	Vinyl Push Plug (1-1/2") Black
	20530490	Washdown Hose w/ Nozzle (15' Blue)
	20170878	Washer Jet (SS) - Bulkhead Mount

These parts should be installed by a certified World Cat dealer. Installation by a non-authorized 3rd party may result in improper performance and create safety concerns. Please contact your local, authorized, World Cat dealer to buy these parts at the same price.

**Price and availability subject to change.**

Service Class	Part Number	Description
	26500298	Water Heater w/o Heat Exchanger (120V/60HZ)
	26500298	Water Heater w/o Heat Exchanger (120V/60HZ)
	20220031	Water Tank 38 Gal
	20140132	Whale 15mm Tubing, Blue (50M/ROLL)
	20140133	Whale 15mm Tubing, Red (50M/ROLL)
	20161447	Wingnut Adapter, 90 Nylon 3/4 HB X 1/2 NPT / for Washdown Pump
	20173467	Wiper Arm (19"-24")
	20170912	Wiper Controls Intermittent Switch

**Service Kits**

	W7013422	Bushing, Stern Seat Black 7/8"ID X 1-1/16"OD
	W7013315	Push Button Point Latch for Cabinets (Plastic/Chrome w/Lock Nut) MP-05-112-11

**Steering**

	W7010050	50amp Fuse Assembly (for Power Steering)
---	----------	--

These parts should be installed by a certified World Cat dealer. Installation by a non-authorized 3rd party may result in improper performance and create safety concerns. Please contact your local, authorized, World Cat dealer to buy these parts at the same price.

**Price and availability subject to change.**

Service Class	Part Number	Description
	W7010050	50amp Fuse Assembly (for Power Steering)
	20180961	6' Hydraulic Hose w/ Bulkhead
	20180961	6' Hydraulic Hose w/ Bulkhead
	20180017	Bracket for Steering System Valve
	20180017	Bracket for Steering System Valve
	20180966	Gem 15" 3-Spoke S/S Steering Wheel w/ Ball Bearing Knob (w/ 1501-- 5/8" wheel nut)
	20180966	Gem 15" 3-Spoke S/S Steering Wheel w/ Ball Bearing Knob (w/ 1501-- 5/8" wheel nut)
	20180941	Gem Steering Wheel Nut (M12 for Uflex/Yamaha Helm Master)
	20180117	Hydraulic Non-Tilt Helm (Sea Star)
	20180022	Hydraulic Tilt Helm Sea Star HH6541
	20180022	Hydraulic Tilt Helm Sea Star HH6541









These parts should be installed by a certified World Cat dealer. Installation by a non-authorized 3rd party may result in improper performance and create safety concerns. Please contact your local, authorized, World Cat dealer to buy these parts at the same price.

**Price and availability subject to change.**

Service Class	Part Number	Description
	20180046	Kevlar 6' Hydraulic Hose w/ Bulkhead
	20180123	Kevlar 8' Hydraulic Hose
	20180118	Non-Vented Helm Plug
	20160481	Power Steering Bracket (Center/320EC)
	20160481	Power Steering Bracket (Center/320EC)
	90180097	Sea Star Cylinder HC5375-3 (Hon/Suz/Yam) (2014 Cylinder)
	90180097	Sea Star Cylinder HC5375-3 (Hon/Suz/Yam) (2014 Cylinder)
	20180062	Seastar Power Assist Unit
	20180062	Seastar Power Assist Unit
	20180018	Steering Whitey Ball Valve
	20180018	Steering Whitey Ball Valve

These parts should be installed by a certified World Cat dealer. Installation by a non-authorized 3rd party may result in improper enforcement and create safety concerns. Please contact your local, authorized, World Cat dealer to buy these parts at the same price.

**Price and availability subject to change.**

Service Class	Part Number	Description
	90410401	Suzuki LH Prop (3 x 16 x 18.5)
	90410400	Suzuki RH Prop (3 x 16 x 18.5)
	20180034	Teleflex Hydraulic Tee
	20180034	Teleflex Hydraulic Tee
	20180031	Teleflex Hydraulic Tee (3/PK)
	20180031	Teleflex Hydraulic Tee (3/PK)
	20180094	Teleflex Power Steering Diode (Keyswitch)
	20180094	Teleflex Power Steering Diode (Keyswitch)

**Upholstery**

	20291095	320EC Billfish Helm Chair w/ 2 Arms (2014)
	20290847	Curtain Large Hatch Cover 320EC (2013MY-MS)
	20290852	Curtain Port Aft 320EC (2013MY-MS)







These parts should be installed by a certified World Cat dealer. Installation by a non-authorized 3rd party may result in improper enforcement and create safety concerns. Please contact your local, authorized, World Cat dealer to buy these parts at the same price.

**Price and availability subject to change.**

Service Class	Part Number	Description
	20290850	Curtain Port Fwd 320EC (2013MY-MS)
	20290848	Curtain Port Hatch Cover 320EC (2013MY-MS)
	20290853	Curtain Stbd Aft 320EC (2013MY-MS)
	20290851	Curtain Stbd Fwd 320EC (2013MY-MS)
	20290849	Curtain Stbd Hatch Cover 320EC (2013MY-MS)
	20290854	Cushion Headboard 320EC (2013MY-MS)
	20290840	Cushion Jump Seat 320EC (P/S) (2013MY-MS)
	20290839	Cushion Jump Seat Back 320EC (P/S) (2013MY-MS)
	20290835	Cushion Port Coaming Pad 320EC (2013MY-MS)
	20290841	Cushion Port Lounge Hatch Seat 320EC (2013MY-MS)
	20290843	Cushion Port Lounge Seat 320EC (2013MY-MS)

These parts should be installed by a certified World Cat dealer. Installation by a non-authorized 3rd party may result in improper enforcement and create safety concerns. Please contact your local, authorized, World Cat dealer to buy these parts at the same price.

**Price and availability subject to change.**

Service Class	Part Number	Description
	20290837	Cushion Port Wrap-Around Backrest/Wing Pad 320EC (2013MY-MS)
	20290845	Cushion Qtr Berth Cushion 320EC (2013MY-MS)
	20290846	Cushion Queen Berth Cushion 320EC (2013MY-MS)
	20290842	Cushion Stbd Lounge Hatch Seat 320EC (2013MY-MS)
	20290844	Cushion Stbd Lounge Seat 320EC (2013MY-MS)
	20290838	Cushion Stbd Wrap-Around Backrest/Wing Pad 320EC (2013MY-MS)
	20290836	Cushion Stdb Coaming Pad 320EC (2013MY-MS)

These parts should be installed by a certified World Cat dealer. Installation by a non-authorized 3rd party may result in improper enforcement and create safety concerns. Please contact your local, authorized, World Cat dealer to buy these parts at the same price.

**Price and availability subject to change.**