



WORLDCAT
GLACIER BAY EDITION

OWNERS MANUAL **2770 / 2780**



WORLDCAT.COM



1090 West Saint James St.
Tarboro, North Carolina 27886

Dear World Cat owner:

Thank you for being our customer. Welcome aboard!

We wish to take this opportunity to sincerely thank you for putting your trust in our boat building team and becoming the newest member of the World Cat Family.

The following manual is designed to ensure you enjoy your new World Cat Glacier Bay Edition for many years to come. We have made every effort to ensure you and your family are safe, enjoy the unique features of a World Cat, and continue to love the World Cat ride that no other boat company can offer.

If you should ever need assistance with the care, maintenance or operation of your boat, then please contact your World Cat dealership; they have experience with the systems and operations of your boat. If for any reason you need additional help, please feel free to contact us at the factory.

Thanks for choosing a World Cat. All of us at the factory and at your dealership are dedicated to earning your confidence.

Again, welcome aboard.

Best Regards,

World Cat

Andrew Brown
President

Best Regards,

World Cat

Anna Bosler
Warranty & Parts Admin
Ph 252.641.8000 x 213
abosler@worldcat.com

TABLE OF CONTENTS

Chapter 1: Customer Information	p. 8
1.1 Owner's Portfolio	p. 8
1.2 Warranty Information	p. 8
1.3 Dealer Responsibilities	p. 8
1.4 Owner's Responsibilities	p. 9
1.5 Manual Legend	p. 9
Chapter 2: Boat Information	p. 10
Chapter 3: Boat Specifications	p. 11
3.1 2770 Standard Boat Specs	p. 11
3.2 2770 Features and Options	p. 12
3.2 2780 Standard Boat Specs	p. 13
3.2 2780 Features and Options	p. 14
Chapter 4: Safety and Regulations	p. 15
4.1 Operator Responsibilities	p. 15
4.2 Registration	p. 15
4.3 Coast Guard Required Safety Equipment	p. 15
4.4 Recommended Safety Equipment	p. 16
4.4.1 Capacity Information	p. 16
4.5 Pollution Regulations	p. 17
4.5.1 Oil and Hazardous Substances	p. 17
4.5.2 Disposal of Plastics/Dunnage/Garbage	p. 18
4.6 Boating Safety Guidelines	p. 18
4.6.1 Pre-Departure	p. 18
4.6.2 Launching	p. 18
4.6.3 Underway: (See Chapter 5 on Performance)	p. 19
4.6.4 Returning	p. 19
4.7 Trailering	p. 19
4.8 Anchoring	p. 20
4.9 Shallow Water	p. 20
4.10 Emergency Situations	p. 20
4.10.1 Emergency Stop Switch	p. 20
4.10.2 Communication	p. 20
4.10.3 Rendering Assistance	p. 20
4.10.4 Reporting Accidents	p. 21
4.10.5 Weather	p. 21
4.10.6 Towing	p. 21
4.11 Carbon Monoxide (CO)	p. 21

TABLE OF CONTENTS

Chapter 5: Performance	p. 22
5.1 Overview	p. 22
5.2 Motor Trim	p. 22
5.3 Engine Controls	p. 22
5.4 Steering Controls	p. 22
5.5 Steering Maintenance	p. 23
5.6 Steering System Diagram	p. 24
5.7 Steering System –Bleeding Instructions	p. 25
5.8 Power Steering System Diagram	p. 26
5.9 Power Steering System Bleeding	p. 27
5.10 Handling Characteristics	p. 27
5.10.1 Turning Characteristics	p. 27
5.10.2 Adverse Sea Conditions	p. 27
5.10.3 Boating Tips	p. 28
5.11 Performance Factors	p. 28
5.11.1 Engine Efficiency	p. 28
5.11.2 Propeller Condition	p. 28
5.11.3 Weather Conditions	p. 29
5.11.4 Load	p. 29
5.11.5 Marine Growth	p. 29
5.11.6 Bottom Paint	p. 29
Chapter 6: Systems Information	p. 29
6.1 Overview	p. 29
6.2 Fueling Guidelines	p. 29
6.3 Fuel System	p. 30
6.3.1 Fuel System Benefits	p. 31
6.3.2 Fuel Tank	p. 31
6.3.3 Fuel Vent	p. 31
6.3.4 Fuel Distribution System	p. 31
6.3.5 IFDV	p. 32
6.3.6 Filling Fuel Tanks	p. 32
6.3.7 Pressure Relief Fuel System	p. 33
6.3.8 Trouble Shooting Tips	p. 33
6.3.9 Integrated Fuel Demand Valve Components	p. 34

TABLE OF CONTENTS

6.4 Ethanol-Blended Fuel p. 34
 6.4.1 Additives p. 34
 6.5 Electrical System p. 35
 6.5.1 Battery System p. 35
 6.5.2 Emergency Parallel p. 35
 6.5.3 Windlass Anchor p. 35
 6.6 Battery Group p. 35
 6.7 Battery Care p. 36
 6.7.1 Safety p. 36
 6.7.2 Exposure p. 36
 6.8 Wiring and Circuit Protection p. 36
 6.9 Control System p. 37
 6.10 Accessories p. 38
 6.10.1 Navigational Lights p. 38
 6.10.2 Cockpit Lights p. 38
 6.10.3 Cabin Lights p. 38
 6.10.4 Spreader Light p. 38
 6.10.5 Bilge Pump/Float Switch p. 38
 6.10.6 Raw Water Pump p. 38
 6.10.7 Freshwater Pump p. 38
 6.10.8 Livewell Pump p. 38
 6.10.9 Macerator Pump p. 38
 6.10.10 USB Outlets p. 38
 6.10.11 Marine Head p. 39
 6.10.12 Anchor Windlass p. 39
 6.10.13 Stereo p. 39
 6.10.14 Windshield Wipers p. 39
 6.10.15 Horn p. 39
 6.10.16 ACC p. 39
 6.11 Gauge Package p. 39
 6.11.1 Yamaha p. 39
 6.12 Plumbing System p. 39

TABLE OF CONTENTS

Chapter 7: Maintenance and Service	p. 40
7.1 Overview	p. 40
7.2 Gelcoat Maintenance	p. 40
7.2.1 Cleaning	p. 40
7.2.2 Waxing	p. 40
7.2.3 Repair	p. 41
7.3 Bottom Paint	p. 41
7.4 Upholstery	p. 41
7.5 Trim/Plexiglas/Polyethylene	p. 42
7.6 Stainless/Aluminum	p. 42
7.7 Bilge Compartments	p. 42
7.8 Cockpit Drains	p. 43
7.9 Winterization	p. 43
7.10 Maintenance Schedule	p. 44
7.11 Maintenance Log	p. 45
7.12 Lewmar Maintenance	p. 46
7.13 Hurricane Preparedness	p. 50
Chapter 8: Warranty	p. 54
8.1 2018 Model Year Limited Warranty	p. 54
Chapter 9: 2770/2780 Operations and Schematics	p. 57
9.1 Operation of Standard Equipment	p. 57
9.1.1 Battery Layout and Management	p. 57
9.1.2 Additional Emergency Parallel	p. 57
9.1.3 Bilge Pump/Float Switches	p. 57
9.1.4 Anchor Windlass	p. 58
9.1.5 Freshwater System	p. 58
9.1.6 Seacocks	p. 58
9.1.7 Livewell System	p. 59
9.1.8 Raw Water System	p. 59
9.1.9 Marine Head	p. 59
9.1.10 Stereo	p. 61
9.2 Maximum Horsepower Rating	p. 61

TABLE OF CONTENTS

Chapter 10: Operation and Schematics **p. 62**

- 10.1 Operation of Optional Equipment p. 62
 - 10.1.1 Shorepower/Charger/Microwave Package p. 62
 - 10.1.2 Microwave p. 62
 - 10.1.3 AC Panel p. 62
 - 10.1.4 Cruiseair Climate Control Package p. 62
 - 10.1.5 Refrigerator p. 63
 - 10.1.6 Cooking Package p. 63
 - 10.1.7 Teleflex Power Assist Unit p. 63
 - 10.1.8 Heavy Duty Stainless Steel Lifting Eye p. 63
- 10.2 System Diagrams p. 64
 - 10.2.1 Access Plate and Rigging Tube Diagram p. 64
 - 10.2.2 Hull Wiring Diagram p. 65
 - 10.2.3 Water Systems Diagram p. 66
 - 10.2.4 Thru Hull Diagram p. 67

Chapter 11: Spare Parts List **p. 68**

Chapter 1: Customer Information

1.1 Owner's Portfolio

To help you enjoy the many features, benefits, and accessories on your new World Cat, we have provided you with the following materials:

World Cat Owner's Manual (model specific)

Vendor Supplied Manuals for various accessories

Delivery Checklist

1.2 Warranty Information

We refer to this package as the "Owner's Portfolio", and will reference it often throughout this text. The portfolio contains a wealth of information, including advice on safety, operation, performance, maintenance, and warranty. Reading and maintaining this information is extremely important, and could be the difference between a positive and negative experience on the water.

For your convenience, World Cat also provides the NMMA text *Sportfish, Cruisers, Yachts Owner's Manual*. It will be referenced occasionally in your owner's manual, and provides supplemental information on safety and basic boating practices.

Warranty Information

Upon purchasing your new World Cat, the dealer is responsible for completing the warranty card provided by the factory. The Dealer is responsible for completing the warranty card and returning a copy to the factory. The Dealer should provide you with a copy to keep in a secure place so it can be referenced quickly in the event of a warranty issue. The 10 year limited hull warranty is transferable, and a copy is included at the back of this manual should you decide to sell your boat.

1.3 Dealer Responsibilities

Our dealers are an extension of the factory, and we expect them to provide you with great customer service and help prepare you for a positive ownership experience. Therefore, we set forth a list of responsibilities for our dealers as follows:

Provide courteous service and explanation of the product prior to the sale.

Provide sea trials, if requested, for potential owners.

Provide a detailed orientation of your boat's features and general operation upon delivery, including safety and performance.

Complete and sign delivery checklist.

Explain, complete, and submit all warranty information in a timely manner after the purchase.

Provide the customer with the "Owner's Portfolio" and explain the information included therein.

Provide service after the sale, or help the customer locate a qualified service at home or away.

1.4 Owner's Responsibilities

As an owner you should also take an active part in the delivery and safe operation of your new catamaran.

Some of your responsibilities are:

Study and understand the limited warranty information.

Read all literature in your "Owner's Portfolio" and operate the vessel in accordance with those instructions.

Perform a walk through prior to the final delivery and ensure that the systems are functioning properly.

Maintain the boat and perform service according to the instructions in this manual, including the 20 hour inspection for the vessel and engines.

It is your responsibility to return your boat to an Authorized World Cat Dealer for warranty work.

Once your warranty information is processed, World Cat will maintain a record of your boat using the Hull Identification Number (HIN), which is located on the starboard side of the transom. Information regarding the dealership, owner, and the factory installed accessories will be recorded to help you should a problem arise. You will receive a survey to rate your purchasing experience and the initial impressions of our company. We ask that you join our family of owners and let us know your feelings about the purchase and the quality of our product.

1.5 Manual Legend

Throughout this manual you will encounter signals to alert of important information. Text printed in bold letters and the warning system shown below is of particular importance. Please review this information prior to reading the manual.

NOTICE

this symbol is not hazard related. it contains information on installation, operation, or maintenance which is needed to ensure the proper operation of your boat.

I WARNING

this symbol alerts you to hazards or unsafe practices which can cause extensive property damage, severe personal injury or death if the warning is ignored.

II CAUTION

this symbol alerts you to hazards or unsafe practices which can cause personal injury or property damage if the warning is ignored.

III DANGER

this symbol alerts you to hazards or unsafe practices which will cause extensive property damage, severe personal injury or death if the warning is ignored.

Chapter 2: Boat Information

Please fill out the following information and leave in this manual for reference. This information will be important for your Authorized Dealer to provide fast and accurate service. To locate your Dealer please call 866-485-8899 or email service@worldcat.com.

BOAT	
Model:	HIN:
Purchase date:	Delivery date:
Ignition Key #:	Door key #:
ENGINES	
Make:	Model:
Serial # Port:	Serial # Sbd:
Propeller Make/Model:	Propeller Diameter/Pitch:
TRAILER	
Make:	Model:
Serial #	
DEALER	
Name:	Salesman:
Dealer Phone:	Service Manager:

Chapter 3: BOAT SPECIFICATIONS



2770



SPECIFICATIONS

- LOA** 27'0"
- Molded LOA** 27'0"
- Beam** 8'9"
- Fuel Capacity** 167 gal (2 x 83.5)
- Freeboard Aft** 25"
- Draft** 20"
- Transom Height** 25"
- Max HP Rating** 300 HP (2 x 150 HP)
- Approx. Dry Weight** 7,400 lbs w/ twin 150's
- Bridge Clearance** 8'8"
- Trailer Height*** 10'1"
- Freshwater Capacity** 20 gal
- Wastewater Capacity** 15 gal
- Typical Cruise**** 17.3 mph/2.2 mpg
- Typical WOT**** 39.8 mph/1.3 mpg

* Measured keel to top of fiberglass hardtop, no outriggers nor electronics (not including the trailer)
 ** Tested with max power, hardtop, two people, 1/2 fuel, no gear

THE PERFECT BOAT FOR MORE FUN OFFSHORE, OVERNIGHT AND UNDER ANY CONDITIONS.

The Glacier Bay Edition 2770 cuddy cabin holds true to the legacy of Glacier Bay boats. While its twin hull design helps eliminate the slamming and pounding of monohulls, it also has the rugged construction that allowed Glacier Bay boats to tackle the toughest waters from the South Pacific to the Bering Strait. Of course, it's ideal for your home waters, too.

- WRAPAROUND L-LOUNGE SEATING
- STARBOARD SIDE ENTERTAINMENT CENTER
- THE CABIN FEATURES LONSEAL TEAK AND HOLLY SOLE
- PRIVATE HEAD AREA WITH PRIVACY CURTAIN

WORLD CAT.COM

3.2 2770 FEATURES



STANDARD FEATURES

Bow

- Lewmar® free-fall windlass for bow pulpit with rode, chain and aluminum anchor
- Dual anchor lockers with molded in bow pulpit
- Bow seating for 2 adults
- Recessed walk around area around cabin
- 316-grade stainless steel bow rail

Cabin

- Queen-sized berth
- Cabin LED overhead lights
- 3 cabin port lights with curtains
- Low profile foredeck acrylic hatch with screen
- Lockable cabin door
- Cabin mirror
- Forward storage compartment with storage nets
- Storage compartments under berth
- Lonséal teak and holly cabin sole
- Freshwater system with 20-gallon tank

Head

- Private head area with privacy curtain, sink, and shower
- Marine head with 15-gallon holding tank and overboard discharge

Helm

- Fiberglass top with powdercoated aluminum frame, integrated VHF box, overhead lights, 6 rocket launchers and spreader lights
- Full wraparound tempered safety glass windshield with center vent
- Starboard windshield wiper with freshwater washer
- Deluxe helm bench seat with flip-up bolster and armrest
- Ergonomic dash layout capable of a 12-inch screen
- Fusion® MS-UD750 marine entertainment system with 4 JL Audio speakers, remote and Bluetooth
- Power-assist steering with 13", 316-grade stainless steel steering wheel
- 2 recessed stainless steel cup holders at the helm
- Starboard entertainment center with fresh water sink and storage with Corian® top, stainless cup holder, and tip-out trash receptacle (optional fridge replaces trash bin)
- Port side L-lounge seating for 4 adults with cushioned backs and laminated foot rests

- Insulated 132-quart L-lounge storage cooler with overboard drains
- Companion grab rail
- Battery select switches with parallel capability

Stern

- Fiberglass entertainment center/wet bar with 20-gallon overboard draining livewell, 4 stainless steel cup holders, and 4 dry storage drawers
- Port and starboard boarding steps
- Raw water washdown with deck fitting
- Port and starboard deck caps with rod and gaff storage for 6 rods
- Insulated 100-quart port and starboard floor fish boxes with diaphragm pumps
- Cockpit LED courtesy lights
- 4 gunwale-mounted stainless steel rod holders
- 2 net 83.5 gallon 2013 EPA approved polyethylene fuel tanks that do not rust and will not emit gas odors
- Walk-through transom with door and heavy duty latch, 2 stainless steel cup holders, and bolsters
- Freshwater pull-out transom shower
- Dual, flush-mounted fold-away aft seats

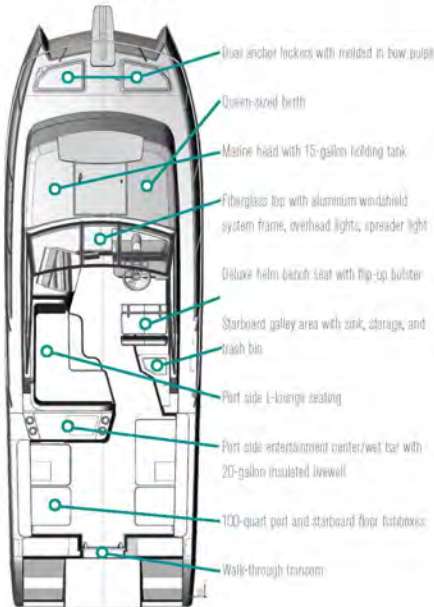

OPTIONS

4-stroke Engine Packages with engines, rigging, controls and props

- Yamaha 150 HP 4-strokes (twin counter-rotating engines, rigging, controls & stainless props)

Accessories

- Entertainment center grill with transom mounts
- Stainless steel refrigerator (replaces trash receptacle)
- Removable L-lounge dinette table
- Heavy duty, reinforced, stainless steel lifting eye

Electronics

- Sea Vision® surface-mount 3-color LED underwater lights (2)
- Electrical conversion kit to 220/240v power
- Shorepower with battery charger, cordset, receptacles and microwave
- Cruiseair® 8,000 BTU heating/ cooling unit with vents to the cabin and cockpit

Top

- Matching hardtop underside color to the hullside



2770



1090 West Saint James Street, Tarboro, NC 27886 866.485.8899
All specifications and options subject to change © World Cat. 05.17

Experience the Ultimate Sea Trial -
find your closest dealer at WORLDCAT.COM

3.3 2780 Standard Boat Specs



WORLD CAT
GLACIER BAY EDITION

2780

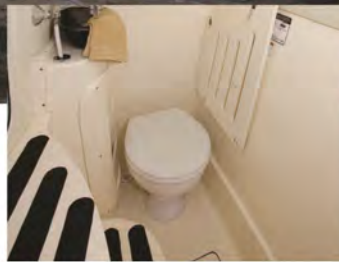

SPECIFICATIONS

- LOA** 27'0"
- Molded LOA** 27'0"
- Beam** 8'9"
- Fuel Capacity** 167 gal (2 x 83.5)
- Freeboard Aft** 25"
- Draft** 20"
- Transom Height** 25"
- Max HP Rating** 300 HP (2 x 150 HP)
- Approx. Dry Weight** 7,800 lbs w/ twin 150's
- Bridge Clearance** 8'8"
- Trailer Height*** 10'1"
- Cockpit Area** 35 sq. ft.
- Freshwater Capacity** 20 gal
- Wastewater Capacity** 15 gal
- Typical Cruise**** 17.7 mph/2.1 mpg
- Typical WOT**** 40.7 mph/1.2 mpg

* Measured keel to top of fiberglass hardtop, no outriggers nor electronics (not including the trailer)
** Tested with max power, hardtop, two people, 1/2 fuel, no gear

THE 2780 DELIVERS SMOOTH SAILING IN EVEN THE TOUGHEST CONDITIONS AND ROUGHEST SEAS.

While the Glacier Bay Edition 2780 hard top offers you a smoother ride without all the slamming and pounding of monohull, it's also designed to protect you from rough seas and rough weather as it glides across the water. Whether it's exploring, entertaining, fishing or just heading out for fun, the 2780 can take you where you want to go, and get you home, in comfort.

- SPACIOUS COCKPIT OFFERS A FULL 360-DEGREES OF VISIBILITY
- THREE-SIDED WINDSHIELD OFFERS PROTECTION FROM THE ELEMENTS
- SPACIOUS BRIDGE COMFORTABLY SEATS SIX

WORLD CAT.COM

3.4 2780 FEATURES



STANDARD FEATURES

Bow

- Lewmar free-fall windlass for bow pulpit with rode, chain and aluminum anchor
- Dual anchor lockers with molded in bow pulpit
- Bow seating for 2 adults
- Recessed walk around area around cabin
- 316-grade stainless steel bow rail

Cabin

- Queen-sized berth
- Cabin LED overhead lights
- 3 cabin port lights with curtains
- Low profile foredeck acrylic hatch with screen
- Lockable cabin door
- Cabin mirror
- Forward storage compartment with storage nets
- Storage compartments under berth
- Lonseal teak and holly cabin sole
- Freshwater system with 20-gallon tank

Head

- Private head area with privacy curtain, sink, and shower
- Marine head with 15-gallon holding tank and overboard discharge

Helm

- Oversized fiberglass top with powdercoated aluminum windshield system frame, integrated VHF box, overhead lights, spreader light and life jacket storage
- Full-deck-to-top wrap-around tempered safety glass windshield with center ventilation openings
- Hardtop sliding overhead ventilation roof
- Starboard windshield wiper with freshwater washer
- Deluxe helm bench seat with flip-up bolster and armrest
- Ergonomic dash layout capable of a 12-inch screen
- Power-assist steering with 13", 316-grade stainless steel steering wheel
- 2 recessed stainless steel cup holders at the helm
- Fusion® MS-UD750 marine entertainment system with 4 JL Audio speakers, remote and Bluetooth
- Starboard entertainment center with fresh water sink and storage with Corian top, stainless cup holder, and tip-out trash receptacle (optional fridge replaces trash bin)

- Port side L-lounge seating for 4 adults with cushioned backs and laminated foot rests
- Insulated 132-quart L-lounge storage cooler with overboard drains
- Companion grab rail
- Battery select switches with parallel capability

Stern

- Fiberglass entertainment center/wet bar with 20-gallon overboard draining livewell, 4 stainless steel cup holders, and 4 dry storage drawers
- Port and starboard boarding steps
- Raw water washdown with deck fitting
- Port and starboard deck caps with rod and gaff storage for 6 rods
- Insulated 100-quart port and starboard floor fish boxes with diaphragm pumps
- Cockpit LED courtesy lights
- 4 gunwale-mounted stainless steel rod holders
- 2 83.5 gallon 2013 EPA approved polyethylene fuel tanks that do not rust and will not emit gas odors
- Walk-through transom with door and heavy duty latch, 2 stainless steel cup holders, and bolsters
- Freshwater pull-out transom shower
- Dual, flush-mounted fold-away aft seats

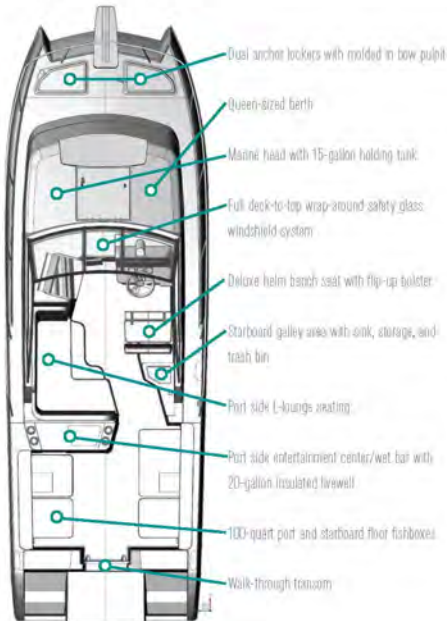

OPTIONS

4-stroke Engine Packages with engines, rigging, controls and props

- Yamaha 150 HP 4-strokes (twin counter-rotating engines, rigging, controls & stainless props)

Accessories

- Entertainment center grill with transom mounts
- Stainless steel refrigerator (replaces trash receptacle)
- Removable L-lounge dinette table
- Heavy duty, reinforced, stainless steel lifting eye

Electronics

- Electrical conversion kit to 220/240v power
- Shorepower with battery charger, cordset, receptacles and microwave
- Cruiseair® 8,000 BTU heating/ cooling unit with vents to the cabin and cockpit



2780



1090 West Saint James Street, Tarboro, NC 27886 866.485.8899
All specifications and options subject to change © World Cat 05.17

Experience the Ultimate Sea Trial -
find your closest dealer at WORLD CAT.COM

Chapter 4: Safety and Regulations

4.1 Operator Responsibilities

Prior to enjoying your World Cat, it is important to read and understand all the information detailed in your "Owner's Portfolio". Knowing how to operate and maintain the systems on your vessel can make your experiences safe and enjoyable, as well as increase the performance and longevity of your boat. Federal law and most state laws clearly indicate that it is the operator's responsibility to maintain their vessel, and to operate it in a manner which protects the safety of their passengers and others. Reference page 10 of the *Sportfish, Cruisers, Yachts Owner's Manual* for a detailed list of owner responsibilities.

This manual will provide you a basic understanding of boating practices; however, we recommend all owners review federal, state, and local regulations regarding safety and traffic prior to using your World Cat. The U.S. Coast Guard Auxiliary and U.S. Power Squadrons offer excellent educational opportunities on a local level and are open to anyone. If a chapter does not exist in your area, reference page 10 of the *Sportfish, Cruisers, Yachts Owner's Manual* or contact the following numbers for other educational opportunities:

Boating Education Hotline 1-800-336-BOAT (2628)

U.S. Coast Guard Boating Hotline 1-800-368-5647

4.2 Registration

Vessels are required by federal and state law to be registered in the state where they are primarily used. Registration numbers and validation stickers must be displayed per regulations, and a certificate of registration must be on board while the vessel is being operated. When traveling away from your home waters, contact authorities at your destination to determine if any additional registration is required. Some areas require permits or temporary registrations to operate in their waters. When completing registration forms you will be asked for the Hull Identification Number (HIN). On your World Cat, the HIN is located on the starboard side of the transom. This number is unique to your boat and will be important for registering your vessel, as well as, communicating with your dealer and our service department. Including this information in any correspondence or conversations will help our support network serve you better.

4.3 Coast Guard Required Safety Equipment

Once you have reviewed safe boating guidelines and filed for registration, it is time to equip your vessel. The U.S. Coast Guard's (U.S.C.G.) list of required equipment is shown below. To review the guidelines for each item, reference pages 23 and 24 of the *Sportfish, Cruisers, Yachts Owner's Manual*.

Audible Signaling Device (Bell, Horn, or Whistle)

Fire Extinguisher

Navigation / Anchor Lights

Flotation Devices (PFD's)

Visual Signaling Devices

NOTICE

Remember to check with state and local agencies to ensure that additional items are not required to operate your boat in their waterways.

4.4 Recommended Safety Equipment

Although not required, there are several additional items which help to ensure safety, and provide convenience for you and passengers. A list of these items can be found in the *Sportfish, Cruisers, Yachts Owner's Manual* on page 24. Perform an annual inventory to keep tools, spare parts, and safety equipment in good condition. Immediately replace any items that have been removed from the kit.

CAUTION

Use only marine grade replacement parts. Most automotive and residential parts are not suitable for use in the harsh marine environment. Using them could lead to premature product failure, property damage, or personal injury.

4.4.1 Capacity Information

On all boats under 26 feet in length, the manufacturer is required to provide capacity information. If you own a model under 26 feet in length you will find a rectangular metal plate near the helm. This plate will provide information on horsepower ratings and total capacities which include person capacities, motor(s) and gear. As an owner you should be aware of the weight on board. Exceeding capacity can endanger your passengers and vessel, as well as void any warranty remaining on the boat should a failure occur. Remember this is a guideline for normal operation, and does not release you from responsibility should an accident occur. You must use rational judgement when adverse conditions are expected, and reduce your loads to create a margin of safety.



This label means your World Cat is certified by the NMMA. With this tag, you are assured your fuel system, electrical system, lighting, ventilation, and steering are not only in compliance with the US Coast Guard regulations, but also meet the more stringent standards of the NMMA. The NMMA is a national trade organization serving all elements of the recreational boating industry including manufacturers of boating equipment. With this tag, you can have confidence in the safety of your boat.



Pursuant to NMMA certification, all World Cats over 26' in length are "Yacht Certified" and carry the placard shown below. Person and gear capacities are not predetermined, they are left to the operator's discretion. Therefore, the amount of load allowed onboard should result from considering all safety precautions.

Horsepower ratings, however, are set by World Cats and should not be exceeded. This manual will provide information on the maximum horsepower ratings for your boat. Exceeding the factory recommendation will result in loss of warranty coverage on your vessel.



4.5 Pollution Regulations

The Refuse Act of 1899 prohibits throwing, discharging or depositing any refuse matter of any kind (including trash, garbage, oil and other liquid pollutants) into the waters of the United States. This information is provided in a pamphlet, that normally received when registering your boat. Use the information below as a guideline, but study the pamphlet and understand any local regulations regarding pollution control. As the operator, you are also liable for individuals on your vessel disposing of materials in an improper manner.

4.5.1 Oil and Hazardous Substances

The Federal Water Pollution Control Act prohibits the discharge of oil or hazardous substances which may be harmful into U.S. navigable water. Vessels 26 feet in length and over must display a placard at least 5 by 8 inches, made of durable material. The placard must be installed in a conspicuous place in the rigging compartments or near the bilge pumps and state the following:

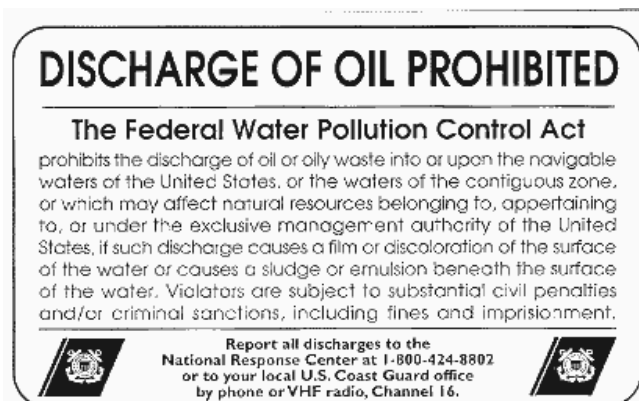

4.5.2 Disposal of Plastics/Dunnage/Garbage

Boats 26 feet in length and over must display a Save Our Seas Placard which outlines the rules for dumping waste offshore. The placards must be at least 4" x 9" and should be displayed in an area visible during normal operation. They can be purchased from your dealer or marine equipment suppliers.



4.6 Boating Safety Guidelines

As an owner/operator you should be prepared to handle any situation which arises before departure, while under-way, or upon return to dock. Careful planning will add safety and pleasure to your experience and give you the confidence to handle emergencies if they develop. Listed below are some general guidelines which you should follow before any trip:

4.6.1 Pre-Departure

Establish a float plan and provide it to a person whom you trust. The plan should give the details of your trip, including where you are going and when you expect to return. If you deviate from the plan, notify that person as soon as possible.

If you anticipate operating in a new area, understand the local rules and request charts or information on any hazards you may not be aware of.

If you are towing the boat, inspect the trailer including tires, lights, brakes, winch, and overall mechanical appearance. *Sportfish, Cruisers, Yachts Owner's Manual page 105.*

Verify that you have all necessary safety equipment. This should include all the USCG required equipment as well as spare parts or other items you decided to include.

Check fuel levels and determine if you require additional fuel for your trip.

Examine the weight of the gear on your vessel and make sure you are not overloaded. Distribute the weight evenly on your vessel to ensure predictable performance.

4.6.2 Launching

- Prepare your boat prior to backing down, (i.e. secure all loose items, install garboard drain), then launch your vessel and move away quickly.
- Move your vessel away from the dock and complete a full system check. Ensure that electronics, pumps, and safety equipment are in working order.
- Instruct a passenger on the operation of the boat, and the location and function of all safety equipment onboard. You should never be the only person capable of safely operating your vessel.

4.6.3 Underway: (See Chapter 5 on Performance)

- Obey all “Rules of the Road” and any local regulations. Use the information located on page 13 of the *Sportfish, Cruisers, Yachts Owner’s Manual* to understand right of way and the various navigational and hazard indicators you will see on the water.
- Never operate a boat under the influence of alcohol or drugs.
- Do not allow individuals under the age of 16 to operate the vessel. Maintain direct supervision of inexperienced operators.
- Ensure that all passengers are safely seated while underway, and are using the hand rails World Cat has provided to remain securely in their seats.
- Use your electronics and judgement to remain abreast of changing weather. Storms develop quickly and you should be prepared to protect your passengers and vessel. See page 22 of the *Sportfish, Cruisers, Yachts Owner’s Manual* for more tips on weather.
- Maintain a safe speed and respect other boaters as well as those on land. Obey all “No Wake Zones” and be aware of smaller vessels. The wake you produce could endanger other crafts and their passengers.
- Know the limitations of your craft and your experience. Understand the boats handling characteristics and do not attempt to operate the vessel in conditions that are unsafe or beyond your experience level.

4.6.4 Returning

- Obey navigational markers and be aware of any tidal changes since departure.
- Collect and dispose of refuse properly to maintain our waters for future generations.
- Prepare your boat for loading before moving to the dock. Quickly pull your vessel from the water and move away from the ramp to complete the preparation for trailering.
- Verify that trailer systems are working properly and all items are secured before leaving.
- Wash the boat and perform general maintenance, upon returning home. (See instructions in Chapter 5).

As stated above, these are only general guidelines for safe boating. We recommend using these and any other available resources to protect your passengers as well as your vessel. Checklists can be an important tool in accomplishing this, see the example on pages 44 & 45 of the ***Sportfish, Cruisers, Yachts Owner’s Manual***.

4.7 Trailering

Due to the nature of the hull, catamarans require specialized trailers. Your dealer will be able to provide them, as well as, information on safe trailering practices. Tow vehicles should be rated to handle the load and stresses which accompany trailering your boat. A properly matched trailer should carry 5-10% of the total vessel weight on the tongue. Routine inspections should be performed on the vehicle and trailer prior to each trip, and thorough checks scheduled on an annual basis.

4.8 Anchoring

World Cat offers an anchor and anchor windlass as optional equipment on all boats. The anchor we supply is known as a plow style. However, there are several types of anchors available, each designed to operate in specific bottom conditions. Your dealer can provide information on which styles are most effective in your area. See page 56 of the *Sportfish, Cruisers, Yachts Owner's Manual* for more information and tips concerning anchoring.

!! CAUTION

Never anchor your boat off the stern. The weight at the transom, combined with adverse sea conditions could allow water to enter the boat over the transom wall.

4.9 Shallow Water

Although your World Cat draws a small amount of water for its size, shallow water should be a concern of all boaters. To avoid this hazard, pay particular attention to navigational markers and know the area you are operating in. Be aware of tidal changes, including those that have occurred during your trip. Rocks, stumps, or other hazards are more prevalent in shallow water and can cause major damage to your hull bottom. Engines can also suffer damage if they are allowed to run in the sand or mud.

If you do become grounded, tilt the motors up to reduce the draft at the transom. Often this will solve the problem; however, it may be necessary to rock the boat from side to side to break the suction along the keel. If you are grounded on an incoming tide, allowing the water to rise can help. Being grounded on an outgoing tide is a larger issue, you need to act quickly to free your boat and avoid being driven further aground. Use the anchor to secure the boat and await the incoming tide, or use it to pull yourself free.

4.10 Emergency Situations

Unfortunately, even the safest boating practices cannot eliminate the potential of emergency situations developing. Therefore you should prepare yourself, and your crew, to handle any problems that may arise. Establish specific plans for fires, man overboard, collision, etc., and review them with your passengers prior to departing. Planning allows people to remain calm, and gives everyone the confidence to resolve the problem. Section 4 of the *Sportfish, Cruisers, Yachts Owner's Manual* provides information on emergency procedures. Below is important information which all owners should be aware of.

4.10.1 Emergency Stop Switch

Lanyard clips are provided on all World Cats and when used properly provide an emergency stop for the engines should the driver fall from the helm position, or need to perform an emergency shutdown to respond to or avoid an accident. The clip attaches the driver to the ignition panel using a cord. A pull on the cord will release the clip from the shut-off switch on the panel and shutdown the engines. To restart the engines, turn ignition switches to the off position, return binnacle to neutral position insert safety lanyard back into clip and then turn ignition switches back on. This should only be used to prevent or react to accidents, and the operator is solely responsible for the decision.

4.10.2 Communication

If you witness an emergency or become involved in one, you should request assistance via radio communication or visual signals. Review the information in Section 4 of the *Sportfish, Cruisers, Yachts Owner's Manual* for detailed information on how and when to request assistance.

4.10.3 Rendering Assistance

Owners are required by law to render assistance to other boaters involved in an emergency situation such as fire, collision, casualty, etc., as long as it does not endanger your vessel or its passengers.

4.10.4 Reporting Accidents

Federal regulations require that operators involved in an accident file a written account of the situation within 48 hours. Reports should be submitted to the State Boating Law Administrator. You can obtain forms through the USCG or local authorities (i.e. harbor patrol, sheriff or police offices). In the event that a casualty or disappearance occurs as the result of an accident, you must notify the authorities immediately by phone or radio and fill out a written statement.

4.10.5 Weather

Pay attention to weather patterns. If you find yourself in the path of a storm, seek shelter immediately. If you cannot reach a dock, seek refuge inside the boat while the storm advances. Never get in the water, and stay clear of metal components on your boat. If lightning strikes, it would likely pass through metal objects seeking a ground.

4.10.6 Towing

Due to an accident or loss of power, it may become necessary to tow another vessel or have your boat towed. If you are providing assistance, never attempt to tow a boat larger than your own. Be certain to use proper lines (ropes) and rational judgement to prevent further damage. Tow lines are under heavy strain, therefore passengers should remain clear of the lines to protect themselves from injury. For more information on towing, refer to page 39 of the *Sportfish, Cruisers, Yachts Owner's Manual*.

4.11 Carbon Monoxide (CO)

One of the most important considerations when dealing with boating safety is carbon monoxide. Commonly referred to as (CO), carbon monoxide is a colorless, odorless, and tasteless gas emitted from any engine exhaust. Including inboards and outboards. A CO particle is close in weight to the air we consume; therefore it does not rise or fall in the atmosphere, but accumulates in enclosed spaces. Boat owners with enclosed heads, cabins, or canvas enclosures should pay particular attention to CO. Be aware that fumes produced on your boat can affect other vessels and other boats can affect you. A primary concern is the use of generators when boats are moored adjacent to each other.

Carbon Monoxide is poisonous and potentially fatal if inhaled over an extended period of time. Symptoms of CO poisoning include:

- Dizziness
- Nausea / Vomiting
- Headache / Throbbing in the temples
- Fatigue
- Muscular twitching
- Inability to focus or think clearly

If you or any of passengers experience any of these symptoms, leave the area and find a source of fresh air immediately. If your symptoms persist, seek medical attention.

!!! DANGER

Carbon Monoxide (CO) is a colorless, odorless, and tasteless gas produced by the exhaust system of any combustible engine. CO can cause brain damage or death, if inhaled over an extended period of time. To protect yourself and your passengers, never block the ventilation outlets in cabins, consoles, or other enclosed spaces.

Chapter 5: Performance

5.1 Overview

This chapter will provide information on the performance characteristics of your catamaran. This is not a substitute for seamanship training or hands-on experience. First time boat owners should use the resources detailed in Chapter 1 to learn proper methods of boat operation. Experienced boaters who have never owned a catamaran, should study this chapter completely. Do not assume that previous boating experience will apply to all situations, as there are several subtle differences in the handling characteristics of twin hulled boats. For existing catamaran owners, this chapter should be a reference.

5.2 Motor Trim

All Models should have weight centered amidships when running at speed. Trimming engines so the boat is running level is normally best for a soft ride. We've also had very good luck with Doelcher "Doel Fins". Typically, you will see about 4% fuel economy increase, combined with a very noticeable decrease in side to side roll underway and at rest. The Doel Fins also increase your ability to trim bow up or down. Doel Fins work best with engines over 360lbs for example Yamaha 150 HPDI's. On smaller lighter engines you may find the Doel Fins add too much lift. You may find that one Doel Fin installed on the outside edge of each engine works well with the lighter engine application. If you feel the ride is not feeling great, we recommend trim up, or down, or increase the speed, 80% of the time makes a solid improvement. If the ride still hasn't improved you may need to slow down. Trim adjustments also can dramatically improve your speed and fuel economy. Find that spot where the speed and RPM climb to their max without a throttle change. Too much weight forward may cause spray to come aboard or in severe conditions, the boat could plow through the waves. When running alone or lightly loaded at high speeds, do not trim the engines too far out from the transom or dangerous bow lifting could result. **NEVER TAKE ANY BOAT TO THE POINT WHERE YOU DO NOT FEEL IN CONTROL!**

5.3 Engine Controls

All factory rigged boats will come equipped with a binnacle control specific to your type of engine. Located at the helm, the binnacle controls the throttle, shift, and trim mechanisms for your engine. For diagrams and general information about this system, review pages 80 thru 83 of the *Sportfish, Cruisers, Yachts Owner's Manual*. Also read the owner's manual provided by your engine manufacturer to determine how to operate the features on your binnacle. If any components of this system need to be replaced, be certain to use the same style and length as the original equipment.

5.4 Steering Controls

Catamarans offer unsurpassed steering control. The wide spacing of the engines, advanced steering components, and handling characteristics of the World Cat hull give operators exceptional maneuverability in even the tightest spaces.

Because of the superior tracking abilities of the World Cat hull, oversteering can present a problem, especially for owners accustomed to operating conventional boats. Conventional vessels have a tendency to lose tracking abilities in rough and following sea conditions, making constant course corrections necessary. However, catamarans do not exhibit those traits and require operators to take a "hands off" approach. To do so, relax your grip and fight the urge to make constant corrections.

5.5 Steering Maintenance

World Cats are equipped with a hydraulic steering system, featuring a single steering cylinder mounted on the aft tunnel tying both port and starboard engines together with a stainless steel link arm. In order to maintain the excellent steering characteristics of your boat, occasionally you will need to visually check all hoses and fittings for leaks and fluid levels. We also recommend checking your link arms to insure all bolts and nuts are still tight.

Similar to hydraulic braking systems in an automobile, it may become necessary to bleed the steering system occasionally to remove air from the lines. We have provided diagrams of the steering system in sections 5.6 thru 5.9 and the Teleflex™ owner's manual in your "Owner's Portfolio". Use the resources, and your dealer, to keep the steering system in excellent working order. Be aware, these are routine maintenance procedures and are not covered under warranty by World Cat.

CAUTION

Routinely check hydraulic fluid levels, and all connections for leaks or any sign of mechanical failure. Lubricate all mechanical parts at least annually with high quality marine grease. Failure to do so may result in impaired or unresponsive steering.

5.6 Steering System Diagram - Standard

HYDRAULIC STEERING

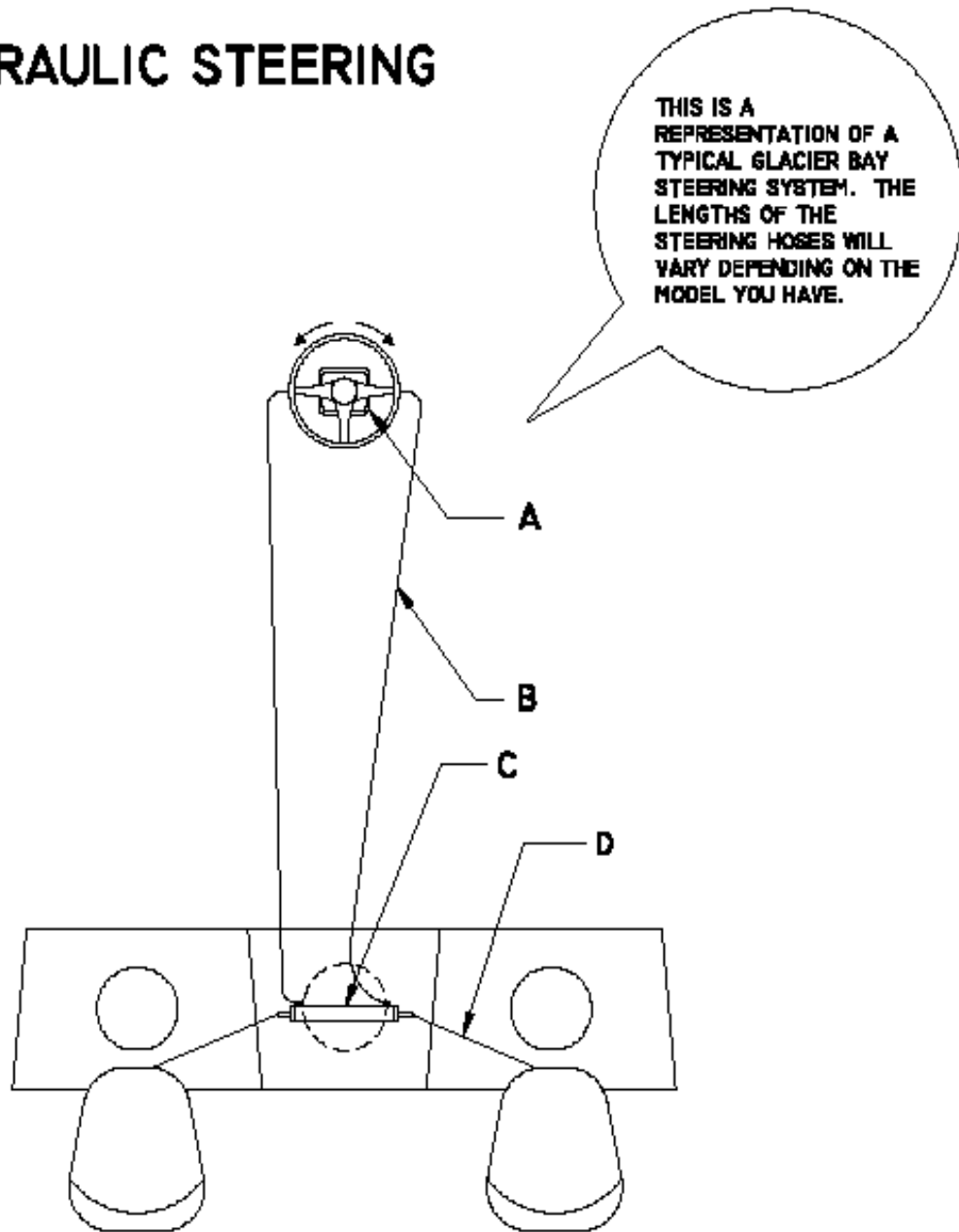

<u>ITEM</u>	<u>DESCRIPTION</u>	<u>QUANTITY</u>
A	SEA STAR II HELM	1
B	STEERING HOSE	2
C	STEERING CYLINDER	2
D	LINK ARM	2

5.7 Steering System- Bleeding Instructions

Reference the bleeding instructions provided by the Teleflex™ owner's manual, which is included in your "Owner's Portfolio". Use them in conjunction with the instructions and diagram below to bleed the steering system. This should be done annually or when air is detected in the system.

NOTICE

If possible, have your dealer or trained marine technician perform routine maintenance or repairs on your steering system. Replace faulty parts immediately.

5.7.1 Step 1

Using a filler tube, fill the helm with oil. When completed, you should be able to see oil in the filler tube. Do not proceed with step two until helm is full of oil.

5.7.2 Step 2

Open the bleed fitting labeled #1 and pull the cylinder shaft all the way out on the fitting #1 side.

Holding the shaft to prevent it from moving back into the cylinder, have someone turn the wheel clockwise until a steady stream of oil flows through the fitting.

Close bleed fitting #1.

5.7.3 Step 3

Open the bleed fitting labeled #2. and pull the cylinder shaft all the way out on the fitting #2 side.

Holding the shaft to prevent it from moving back into the cylinder, have someone turn the wheel counter-clockwise until a steady stream of oil flows through the fitting.

Close bleed fitting #2.

5.7.4 Step 4

When you complete the bleeding process, turn the wheel hard over in each direction at least twice. Then manually adjust the cylinders by pulling the shaft all the way out on the same side of each cylinder and closing the steering system valve.

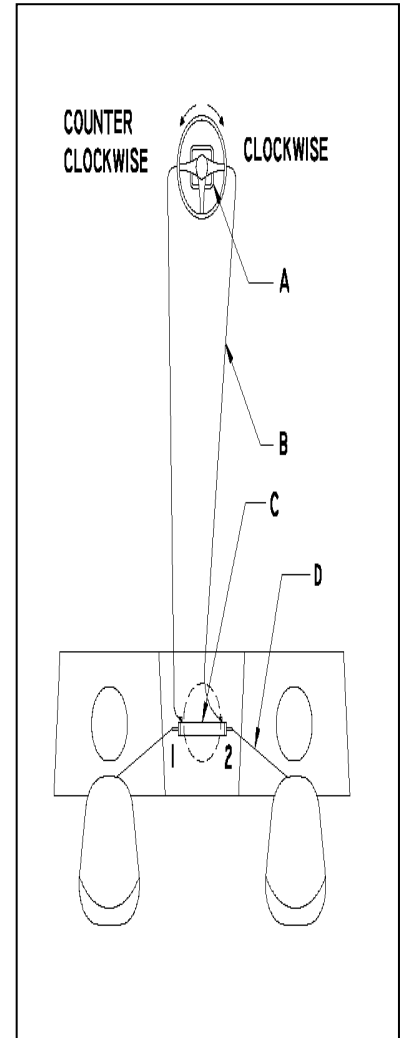

5.8 Power Steering System Diagram

HYDRAULIC POWER STEERING

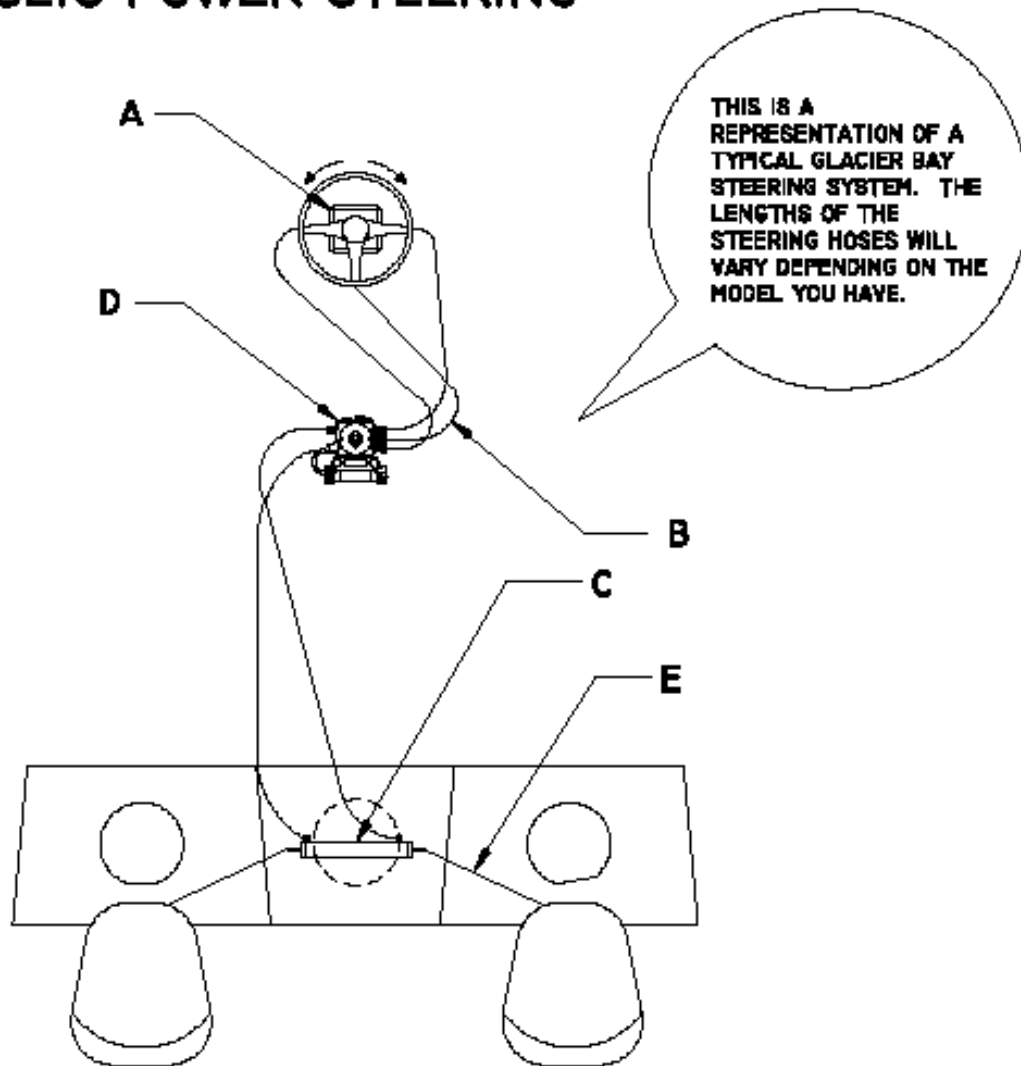

<u>ITEM</u>	<u>DESCRIPTION</u>	<u>QUANTITY</u>
A	SEA STAR II HELM	1
B	STEERING HOSE	3
C	STEERING CYLINDERS	1
D	TELEFLEX POWER STEERING PUMP	1
E	LINK ARM	2

5.9 Power Steering System- Bleeding Instructions

Reference the bleeding instructions provided by the Teleflex™ owner's manual, which is included in your "Owner's Portfolio". Use them in conjunction with the instructions in section 5.7 bleeding the steering system. This should be done annually or when air is detected in the system.

NOTICE

If possible, have your dealer or trained marine technician perform routine maintenance or repairs on your steering system. Replace faulty parts immediately.

5.10 Handling Characteristics

World Cat Glacier Bay Edition catamarans have semi-displacement hulls. Semi-displacement hulls provide superior handling characteristics, even at low speed, and an improved ride in rough water. Our proven design provides a superior ride, excellent handling characteristics in a variety of conditions, and speed with economy of operation. To help you experience the softest ride, study the following sections

5.10.1 Turning Characteristics

Turning a catamaran is slightly different than cornering on a conventional vessel. Imagine the difference between an automobile and a motorcycle. Automobiles take turns in a flatter, more stable, manner similar to catamarans hulls, while motorcycles pitch hard into a turn similar to a monohull. Do not underestimate a catamaran's cornering ability however, hard adjustments to the steering wheel can make a World Cat bite quickly and execute high performance turns. Experiment with the handling ability of your cat so you are prepared for any situation on the water.

5.10.2 Adverse Sea Conditions

Catamarans are designed to handle some of the roughest waters in the world, but that is no substitute for common sense. As an operator you are responsible for the safety of your passengers and vessel; therefore, your trips should be limited by your level of experience. Planning and paying constant attention to the weather and sea conditions is paramount. If you are forced to operate in dangerous seas however, you can be confident that your World Cat, when operated properly, can handle them safely. Following are some tips on how to handle your boat in adverse sea conditions:

When traveling into the wind, changing your direction a few degrees to allow one sponson to settle before the other, can make the ride smoother and allow for increased speed.

In a rough chop with short wave intervals, increasing your speed may allow the boat to skim across the tops of each wave. This will result in a smoother ride.

Steer to avoid larger swells and breaking waves.

In a following sea, position your vessel on the back of a wave and match its speed to remain ahead of the trough. Speed is paramount. Work the throttle to avoid going over the wave or being thrown down the face of a following wave.

5.10.3 Boating Tips

Experience is the best way to determine the handling characteristics of your catamaran. Operating the boat in multiple sea conditions and under various loads will help you predict how the boat will perform in any situation. World Cat provides the following recommendations regarding the performance of your catamaran:

Establish an RPM chart which details the speed and fuel consumption at various RPM levels to achieve the most economical operation.

2. Monitor fuel gauges to determine the amount of operating time remaining at a given reading.
3. Determine minimum speed for effective steering in close quarters.
4. Determine the turning radius required at various speeds.
5. Determine the rates of acceleration and deceleration with various load conditions. Include the distance required to stop the boat at various speeds.

Use the information provided in section 6 of the *Sportfish, Cruisers, Yachts Owner's Manual* for more information on boat handling.

5.11 Performance Factors

Proper setup and maintenance of the systems on your boat is important to ensuring proper performance, but be aware they are not the only factors which affect it. Several things which contribute to the level of performance of your catamaran can change between or during trips.

5.11.1 Engine Efficiency

Without proper maintenance, your engine(s) will gradually lose power, resulting in a loss of speed. Use the recommendations in the engine's owners manual to schedule routine maintenance procedures and as a guide for the correct RPM range for your engines. Neglecting to do so may result in loss of performance and an increased risk of failure.

5.11.2 Propeller Condition

The size and condition of your prop also plays a major role in the performance of your catamaran. A damaged prop can result in lower speeds, sudden drops in RPM, increased fuel consumption, and severe vibration while running. Improperly sized props can cause damage to your engine as a result of exceeding the maximum or minimum RPM levels.

5.11.3 Weather Conditions

Barometric pressure and humidity can affect the output of your engines. For example, on an extremely hot and humid day, your engine can experience as much as a 10 percent loss in horsepower. Although you should monitor your engines' performance, be aware that the weather could be a major factor in your boat's performance.

5.11.4 Load

Increased load can obviously affect performance, especially if the load is unbalanced. Passengers, gear, and fuel are all examples of things which can affect your vessel. Fuel levels change through the day, and greatly affect the attitude of your boat. When necessary, make adjustments to engine trim and load distribution to compensate for fuel usage.

5.11.5 Marine Growth

If you store your boat in the water or fail to clean it after each trip, the existence of marine growth can contribute to a loss of performance. A decline in speed or increased fuel consumption can occur. Prevent this by applying a marine growth inhibitor or by cleaning your boat thoroughly after each trip.

5.11.6 Bottom Paint

Bottom painting your catamaran will also change the performance. Although not significant, you can expect a drop in speed between 1 and 5 miles per hour.

Chapter 6: Systems Information

6.1 Overview

This chapter will provide you with basic information for all the systems on your boat. Understanding this information is imperative, as it directly contributes to the safety and enjoyment of your trips on the water. If you need further information on any of these systems talk with your dealer.

6.2 Fueling Guidelines

Study the following guidelines thoroughly, and consult your dealer if you have questions. Be sure to read the engine manufacturer's recommendations regarding the type and grade of fuel to use for your engines. When you are using an outboard engine, be sure to fill the oil tanks with manufacturer approved oil during each fill-up.

⚠ WARNING

Avoid methanol or other alcohol based fuels or additives which can deteriorate fuel hoses, Alcohol based fuels also absorb water which can lead to engine damage.

!!! DANGER

Follow all safety guidelines while fueling. Leaking or spilled fuel is an explosion hazard. Regular checks of the fuel system are needed to protect you and the vessel.

!!! DANGER

Static electricity can ignite gasoline vapors causing serious injury, death and /or destruction of property.

Before Fueling

- Shut down the engines and turn off all electrical devices including the batteries.
- Close all hatches, port lights, and doors to prevent accumulation of fuel vapors.
- Extinguish cigarettes or other lighted materials.

Keep a properly charged and correctly rated fire extinguisher nearby.

During Fueling

- Use common sense and obey all safety regulations related to fuel handling.

Avoid static sparks by maintaining contact between the fuel nozzle and fuel fill.

After Fueling

- Secure the fuel cap and inspect for leaks.
- Clean up any spilled fuel and dispose of the cleaning material accordingly. Do not store fuel soaked material on your boat.
- Open all hatches, port lights, and doors to allow for ventilation.

Check for fuel vapors using a "sniff test" and do not turn on electrical devices, including batteries, until you are certain the fumes have dissipated.

6.3 Fuel System

Due to the nature of the hull design, your World Cat is equipped with a port and starboard fuel system. These systems act independently, providing fuel to the engine on their respective side. Tanks are constructed of polyethylene material to prevent corrosion.

Hose are NMMA certified, and fittings are clamped securely to reduce the potential for leaks. However, comprehensive checks of hoses and fittings should be completed at least annually, including those normally hidden from view. Tighten all connections, replace deteriorated hoses, clamps or fittings, and replace the fuel/water separators during this check. World Cat has provided inspection plates in the cockpit floor and along the gunwales to assist you with annual maintenance. To access the inspection ports along the gunwale, you will need to remove the cockpit bolsters by removing the screws that hold it in place. To access the screws, pull up gently on the bottom of the bolster and locate the frame grommets. The factory installs screws in every other grommet to secure the bolster. Remove these and pull up and out on the cushion to remove.

If you experience fuel flow problems, remove the fuel feed hose from your engine and connect it to a portable fuel tank. Doing so will help you determine if your fuel system or the engine is the source of the problem. Fuel system repairs and engine maintenance should be performed by a qualified marine technician.

The fuel/water separators are installed between the tank pickup and the engine. They are located in the aft rigging space. Inspect these filters regularly and replace when needed.

6.3.1 Fuel System Benefits

- Automotive style refueling
- Automotive Nozzle shut-off
- Fuel Nozzle retention
- System send signal to the pump nozzle to shut off before there is any spit-back through the fill opening
- Overfill protection – reducing the possibility of accidental fuel spills

Reduce hydrocarbon emission through the use of specially designed fuel fill. The fuel fill has a permanently attached cap with a positive closure mechanism with and audible click, to let you know when the cap is sealed.

6.3.2 Fuel Tank

Your boat is equipped with a Low Permeation Crosslink Polyethylene fuel tank with a fuel capacity of 84 gallons per tank. The useable capacity of the fuel tank is different from the tank capacity marked on the tank from the manufacturer. The difference is the ullage area that has been incorporated into your tank. It is recommended that you follow all the instructions regarding the filling of fuel tanks.

6.3.3 Fuel Vent

The fuel tank vent is integrated into the fuel fill deck fitting (See fig. 6.3.6) The vent serves as an over pressure/vacuum release with anti-surge and flame/spark arresting protection. The fuel vent system also plays an important role in controlling the "FULL" level of fuel with the use of FLVV (Fill Limit Vent Valve). Grade Valves have been added to the tank which allows proper ventilation of the tank when the boat is stored, or trailered, on a moderate incline, without fuel. Note all ways inspect to insure the fuel fill deck fitting is free of debris and in proper working condition.

6.3.4 Fuel Distribution System

The fuel is delivered from the tank to the engine through the "Integrated Fuel Demand Valve" (IFDV), anti-siphon valve, and the fuel line. The IFDV prevents the built up pressure inside the tank from being transferred to the engine while still allowing fuel to flow as the engine requires it for operation. The anti-siphon valve is a safety feature designed to prevent the fuel from siphoning out of the tank if the fuel line were to be cut or broken below the level of the fuel in the tank. In this case, some fuel would leak from the line, but will not allow the entire contents of the tank to siphon into the boat. (See fig 6.3.6)

6.3.5 IFDV

What does the IFDV do?

- The integrated fuel demand valve, used in conjunction with integrated fuel systems, is for below deck use, eliminates pressurized fuel from reaching fuel distribution lines and your engine and ensures that fuel is provided to the engine on demand rather than as a result of pressure in the tank. Additional features include:
 - Compatible with Ethanol blended fuels
 - Eliminates the need for rigid fuel distribution lines in pressure relief systems (per ABYC H-24.15.9)
 - 2 year warranty



4

6.3.6 Filling Fuel Tanks

The fuel system is designed to automatically shut off the fuel nozzle when the tank is full by the "Inlet Control Valve" (See Fig 6.3.6) similar to an automotive fuel system. The tank is filled when the fuel fill nozzle has shut itself off the second time. Attempting to fill the tank past this point may cause some of the components to not function properly, or malfunction.

! WARNING

The use of a portable fuel tank to fill your fuel tanks can result in overfilling and circumvent the safety features designed into your fuel tank system.

! WARNING

Modification of any of the fuel system components or the replacement of these components with unauthorized parts may result in over-pressurization of the fuel system and circumvent the safety features designed into your fuel system.

6.3.7 Pressure Relief Fuel System Diagram

Pressure Relief Fuel System

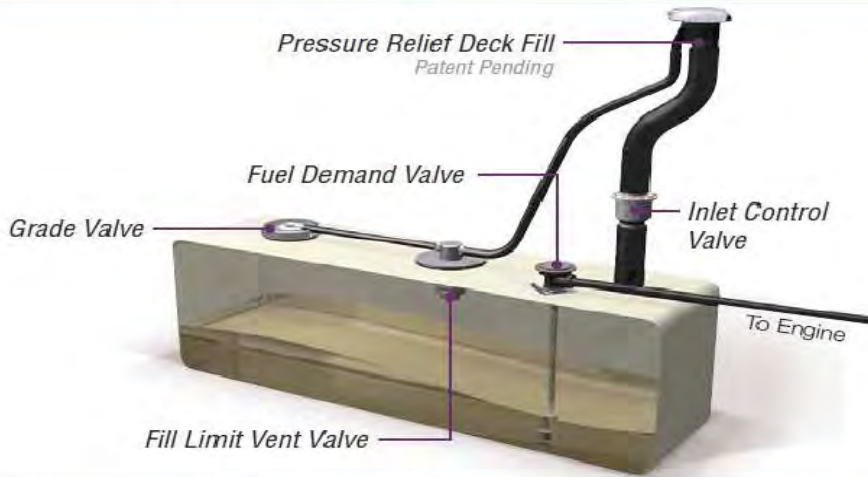

6.3.8 Trouble Shooting Tips

Possible Failures

- Loss of prime on the engine and or fuel starvation.
 - Symptom Engine runs normally stalls out.
 - Engine runs lean.
 - Engine does not draw fuel properly.
- Corrective action.
 - Possible leakage points
 - Fuel line leak from tank to engine – replace components as needed
 - IFDV O-Ring – replace O-Ring
 - Pick up Tube O-Ring – Replace O-Ring
 - IFDV – Replace IFDV

6.3.9 Integrated Fuel Demand Valve Components

IFDV Components



6.4 Ethanol-blended fuel

Ethanol is an oxygenated hydrocarbon compound that has a high octane rating, therefore is useful in increasing the octane level of unleaded gasoline.

NOTICE

The use of improper gasoline or additives can damage your fuel system and is considered misuse of the system. Damage caused by improper gasoline or additives WILL NOT be covered under warranty.

6.4.1 Additives

World Cat exclusively powers every boat with Yamaha Outboards. Under its Maintenance Matters program, Yamaha recommends the following additives be used to maintain your new outboard at top performance . **Yamalube Fuel Stabilizer & Conditioner** to protect against the damaging effects of today's ethanol fuels, and **Yamalube Ring Free** to prevent carbon build up.

See your Yamaha owner's manual and your authorized Yamaha dealer for more detailed maintenance instructions.

6.5 Electrical System

The electrical system on your catamaran consists of three major components: the battery system, wiring and circuit protection, and accessories. It is important that you understand the principles of the electrical system, so that you can protect the components and troubleshoot any problems you experience.

6.5.1 Battery System

Your World Cat is equipped with three batteries. Two of the batteries are dedicated as "cranking batteries" the third bank controls the DC accessories and is commonly referred to as the "house" bank. To help maintain your batteries, a management system is installed on your boat. In Section 9.1.1 & 9.1.2 of this manual will provide details regarding the location and wiring of your batteries.

6.5.2 Emergency Parallel

In the event of a battery failure, the battery management panel allows you to mechanically link the port "cranking" battery to the starboard engine or vice versa. Please refer to the model specific section for more details.

The push-in or toggle style breakers located across the top of the management panel protect the 24 hour essential circuit wiring. Per NMMA and USCG guidelines, these breakers are constantly energized to provide power for bilge pumps and memory functions. This helps to protect your vessel even when you are not available. The "HOUSE" switch does not need to be "ON" for these breakers to have power. Inspect the breakers regularly, and push-in or flip the toggle to reset. If a breaker trips constantly, have your dealer investigate the problem as soon as possible to prevent damage to your boat.

!!! DANGER

Disconnect the battery cables from the batteries prior to removing or working on the battery management panel. Failure to do so could result in electric shock. Reference the NMMA pamphlet in your "Owner's Portfolio" for more information.

6.5.3 Anchor Windlass

A 50 Amp breaker is installed at the factory for owners who request the anchor windlass option, otherwise a blank is installed to permit aftermarket additions. If you choose to add a windlass to your boat, contact your dealer for information on selecting a breaker to fit the panel.

Battery Selection

World Cat supplies the original batteries onboard your vessel. We use Group 27 batteries. In the event of a failure, replacements must be of equal size and specifications (see below):

GROUP 27 (27MG)

CCA: 840

MCA: 1050

RESERVE CAPACITY: 182 min @ 20A

6.7 Battery Care

Batteries should be secured in a non-metallic tray and insulated boots should cover the terminals. Depending on the style of battery you choose, inspect the electrolyte and perform routine maintenance as suggested by the manufacturer. Remove corrosion from the terminals quickly to prevent failure. Use a stiff brush and a solution of water and baking soda to remove corrosion, then grease the terminals to prevent further build-up. Be careful to clean up thoroughly to avoid contaminating the electrolyte.

When servicing the batteries, follow the safety procedures shown below and work to avoid electrolyte spills which can harm you and your vessel.

!!! DANGER

All batteries contain an electrolyte, commonly sulfuric acid, which is a caustic and volatile chemical. Use extreme caution when charging or servicing.

6.7.1 Safety

Use protective clothing and accessories such as aprons, gloves, and eye wear to protect yourself while servicing batteries. Avoid cigarettes, open flames, and sparks. Batteries can produce toxic and explosive gases; therefore, store or charge them in a well ventilated space.

Keep batteries out of the reach of children and pets.

6.7.2 Exposure

If you are exposed to the electrolyte solution, follow these procedures and seek immediate medical attention.

EXTERNAL - Flush with large amounts of water for contact with the skin. If severe irritation occurs or it contacts your eyes, seek medical attention immediately.

INTERNAL - Consume large amounts of water or milk, coupled with milk of magnesia, a beaten egg, or vegetable oil. Seek medical attention immediately.

The guidelines above are basic and do not alleviate the owner of responsibility should an accident occur. Use good judgement and common sense to avoid an accident.

!! CAUTION

When reconnecting your batteries, always connect the black cable to the negative terminal and red cable to the positive one. Reversing them can damage your electrical system and create the potential electric shock.

!! CAUTION

Never disconnect a battery while underway. Doing so may result in damage to your boat's electrical system and the engine's alternator.

6.8 Wiring and Circuit Protection

All World Cat are wired using marine grade tin coated copper wire, instead of standard copper wire. Tin coated copper is manufactured to withstand the harsh saltwater environment better than standard copper, which is used for residential applications. Environmentally sealed Deutsch™ connectors are installed on all accessories located below the waterline to ensure watertight connections. The remaining devices are installed with high quality splices and terminals, which are heat shrunk to protect the integrity of the connection. Harnesses are routed through PVC rigging tubes to prevent chaffing and covered with sheathing when necessary.

6.9 Control System

World Cat 2770/2780 comes equipped with a digital assembly consisting of a control unit and remote switch pod(s). In the digital assembly, the control unit houses the circuit protection for all the accessories controlled by the switch pod(s). A label is mounted on the control unit to advise you which breaker controls a given appliance. If a breaker trips, simply push it in to reset. When possible have your dealer replace defective electrical components. If that is impractical, be certain to use identical replacements to ensure the integrity of the system. Please refer to section 10.2.5 for diagram.

!! CAUTION

Failing to use the correct replacement breaker could result in failure of the device or damage to the electrical system. Contact your dealer for repair information.

Accessories not integrated into the control unit can include lights with integrated switches, marine head controls, stereos, aftermarket electronics and 12V outlets. These devices draw current from the accessory fuse blocks. The fuse blocks are similar to those found in automobiles, and use snap-in fuses to protect a circuit. You can obtain replacements for these fuses from your dealer or local auto-parts store. Always replace a damaged fuse with one of equal rating.

Ground blocks are another integral part of your electrical system. These are connected to the common battery ground and individual appliances, to provide a path for current flow back to batteries.

!! CAUTION

When working on your electrical system, disconnect the batteries to prevent shock, or damage to your electrical system. If possible, have an electrician perform repairs.

For customers unfamiliar with electrical systems, World Cat recommends the following book:

Boating Magazine's: Powerboater's Guide to Electrical Systems

Written by: Ed Sherman

Publisher: International Marine (Division of McGraw Hill Companies)

Copyright: 2000 International Marine

6.10 ACCESSORIES

Electrical accessories include all lights, pumps, and gauges assembled into your catamaran. Certain accessories are standard to each model, while others are optional equipment. Below is a list of accessories and their function. For information on optional equipment see section 3.2 in this manual.

6.10.1 Navigational Lights

Per USCG guidelines, all powered vessels must have navigational and anchor lights. Every World Cat is equipped with navigational lights at the bow, a pole light near the stern, or mast light on the hardtop. These lights must be used in accordance with USCG regulations when anchored or underway.

6.10.2 Cockpit Lights

Cockpit lights are located at floor level to provide light while operating in low light conditions.

6.10.3 Cabin Lights

Lights located in the cabin or in consoles have an integrated power switch and are tied directly into the fuse block. Operate them with the switch located at the base of the light.

6.10.4 Spreader Light

Attached to the hardtop spreader light illuminate the cockpit in low light situations. They are operated using the switch on the instrument panel and are protected by a fuse block

6.10.5 Bilge Pump / Float Switch

Bilge Pumps evacuate standing water in the bilge. They can be operated manually, or automatically by the float switch. The float switches are connected to the fuses along the top of the battery management panel.

6.10.6 Raw Water Pump

Supplies pressure to the raw water system. It contains a pressure switch similar to a residential well pump. You can leave this appliance on at all times while underway.

6.10.7 Freshwater Pump

Supplies pressure to the freshwater system. It contains a pressure switch similar to a residential well pump. You can leave this appliance on at all times while underway.

6.10.8 Livewell Pump

Supplies water to the livewell system and is activated by the rocker switch. See section 9.1.6 in this manual for operating instructions.

6.10.9 Macerator Pump

Used to evacuate waste and debris from fishboxes or to remove waste from marine head holding tanks.

6.10.10 USB Outlets

Located strategically throughout the boat, these outlets provide power to aftermarket accessories such as cell phones, electric reels, and spotlights. Each outlet is independently wired to the fuse panel.

6.10.11 Marine Head

The marine head is powered by the fuse panel, and has a separate control panel mounted near the head. The control panel activates the solenoid to allow for water intake and discharge. A macerator pump is incorporated into the head.

6.10.12 Anchor Windlass

Use to deploy and retrieve the anchor. This accessory is controlled by a dedicated switch at the helm and can also be controlled at the bow with up & down foot switches. The fuse is located at the battery management panel. See section 10.1.1 in this manual for operating instructions.

6.10.13 Stereo

Similar to an automotive stereo, the unit can be operated using the faceplate or a remote keypad which is mounted near the helm. It is powered by the fuse block, and the memory wire is connected to a 24 hour circuit.

6.10.14 Windshield Wipers

Operated by a dedicated rocker switch at the helm, these function identically to those found on passenger automobiles.

6.10.15 Horn

Function identically to those found on passenger automobiles.

6.10.16 ACC

"ACC" switches can be used to operate aftermarket products. Be aware of the power requirements for any add-on products, so you do not exceed the capacity of the breaker supplying the switch. Failure to do so could damage the appliance and/or the electrical system.

6.11 Gauge Package

World Cat provides Yamaha™ engine packages with manufacturer supplied instrumentation. Below is a list of the standard packages and a description of their function.

6.11.1 Yamaha™

Yamaha™ packages feature a three piece digital gauge package on all models with a tachometer for each engine and combination speedometer / fuel management gauge. Instructions on the operation and features of these gauges is included in your engine owner's manual.

6.12 Plumbing System

The intake and discharge of water is integral to several of the features and accessories provided on your boat, including livewells, fishboxes, sanitation devices, and water systems. World Cat installs the plumbing components for these systems using high quality marine hoses and stainless clamps. However, this does not eliminate the need for routine checks of plumbing components or connections. A failure resulting from a deteriorated hose or connection, could cause your boat to take on water or become swamped. Information is provided in Chapter 9 & 10 of this manual, regarding the location, function, and routing for the plumbing components on your boat. Review these materials and talk with your dealer should you have a question.

Chapter 7: Maintenance and Service

7.1 Overview

This chapter provides basic information for maintaining the original appearance and dependable performance of your World Cat. Although your vessel is constructed of the finest materials available, the harsh saltwater environment and other factors, including geography and usage rate, will affect its finish and function over time. It is imperative that you understand how to care for your catamaran properly. Some simple steps will help maintain its aesthetics, value, and reliability.

7.2 Gelcoat Maintenance

Gelcoat is a thin layer of resin mixed with colored pigments, which provides the exterior finish on your boat. Gelcoat provides a smooth durable surface to protect the fiberglass construction of the hull, but is still flexible enough to absorb the pressure exerted upon it during operation. Mainly used for cosmetics, gelcoat is relatively simple to maintain. However, without routine cleaning, it will discolor due to the microscopic pores in the surface. Following are some instructions for maintaining your gelcoat.

7.2.1 Cleaning

After each trip on the water, or after trailering long distances, you should clean the boat immediately. Washing the boat with mild detergents, such as dishwashing soaps, and fresh water will help eliminate build up or dis-coloration resulting from environmental pollutants. Use a sponge or other soft cleaning device on the smooth exterior surfaces of the hull and deck. A soft brush can be used when cleaning nonskid portions of the deck. Make sure to rinse the boat thoroughly after cleaning.

!! CAUTION

Using strong or caustic cleaning agents, such as bleach, citrus based cleaners, or one containing ammonia, will damage the appearance and strength of your gelcoat.

7.2.2 Waxing

Similar to automotive finishes, gelcoat will begin to fade over an extended period of time. Constant exposure to environmental pollutants and this aging process will result in a loss of shine. However, it is possible to restore the original luster and color using a polishing compound (mild abrasive) or a rubbing compound (harsh abrasive). Each will remove scratches, discoloration, and help restore weathered gelcoat surfaces but you should select what to use based on the severity of the problem. Use the following steps to restore the finish of your gelcoat.

Clean the affected area completely using a mild detergent.

Gently wet sand the affected area using a fine sandpaper (600 grit) to remove any stains. Use plenty of water and always sand in one direction using curved strokes. Sanding in alternating directions could result in damage to the finish.

Apply polishing compound to a buffing pad and follow the manufacturers instructions. If you apply the compound mechanically, we recommend a lamb wool buffing pad and a electric buffer capable of 1750 to 1800 RPM.

When you have completely buffed the area, wash away any remaining compound using clean water.

After thoroughly cleaning the surface, wax the affected area. This will help restore the finish and provide a seal against future discoloration.

!! CAUTION

Protect metal surfaces when using abrasive cleaners, polishing compounds or rubbing compounds. They can damage the metal's protective finish leading to rust.

! CAUTION

When using an electric buffer, maintain constant motion. Allowing the pad to rest on an isolated spot can cause heat buildup, which can damage the gelcoat.

! CAUTION

Routinely clean and wax your catamaran to help prevent the need for excessive use of rubbing and polishing compounds, which over time can deteriorate the gelcoat.

By following the instructions listed above you can guarantee that your catamaran will remain in near showroom condition and remain a source of pride for years to come.

7.2.3 Repair

Although gelcoat is a flexible material capable of handling environmental punishment and extended use, it is susceptible to scratches, blistering and cracking over time. Gel coat distortion or cracking is unappealing, but rarely represents any structural failure. Have your dealer inspect any damage to your gelcoat to determine the nature of the failure. If it is only cosmetic, they can provide color matched kits, instructions, and any chemi-cals you need for application or cleanup. Structural damage should be repaired by your dealer or a trained repair shop.

! WARNING

Gelcoat and the chemicals used for its application and cleanup are extremely flammable and toxic. Follow all handling and mixing instructions, provide for proper ventilation, and keep water containers nearby to submerge catalyzed materials.

7.3

Bottom Paint

If you intend to leave your boat in wet storage, or routinely dock it for more than a few days, you should coat the hull beneath the water line with anti-fouling paint. This will help prevent marine growth, such as barnacles, which damage the gelcoat and affect performance. World Cat recommends using an epoxy barrier coat prior to boating painting a new vessel. This will help to prevent, but not eliminate, gelcoat blistering on the hull, which is not war-ranted by World Cat. Your dealer can provide information on bottom painting to protect against environmental toxins in your area. Anti-fouling paints are made to dissolve over time, so inspect and clean the hull bottom annually and recoat when necessary.

7.4 Upholstery

Basic Stains - Clean with a mild detergent and a soft to medium brush, or an all purpose cleaner such as Fan-tastic™. Rinse with fresh water after cleaning.

Mildew - Use a 4 to 1 mixture of water and ammonia, brushing the stain vigorously to remove the bacteria responsible for the mildew. If the stain remains, briefly apply bleach to the area and rinse with fresh water.

WARNING

Do not mix ammonia and household bleach. Doing so will result in the formation of deadly chlorine gas. If it is necessary to use bleach, clean up any traces of ammonia and ventilate the work space for a minimum of 15 minutes prior to applying bleach.

Tough Stains or Mildew - Use a mixture of 1 tablespoon of ammonia, 1/4 cup of hydrogen peroxide, and 3/4 cup distilled water. Briefly, apply to the surface, allowing the peroxide to bubble. Rinse with fresh water.

7.5 Trim / Plexiglas / Polyethylene

World Cat uses vinyl, Plexiglas, and polyethylene material (Starboard™) throughout the interior of our catamarans. Use the following instructions to care for these items:

Use mild detergents to clean vinyl trim commonly used in cabins and helm. Routinely use a commercially available surface protector to seal the vinyl.

Surface or glass cleaners can be used to clean Plexiglas. It is commonly used for radio boxes and as a protective material for instrument panels.

Starboard™ can be cleaned using surface cleaners such as 409™.

7.6 Stainless / Aluminum

Stainless steel and aluminum are used throughout your vessel. World Cat uses only 316 marine grade stainless hardware and anodized aluminum to provide you with years of service; however, these metals can deteriorate and fail if improperly cared for. Upon returning, clean all hardware using a mild detergent and rinse thoroughly with fresh water. Avoid using abrasive cleaners or chlorine based products, as they will remove the metal's protective coating and lead to pitting or rust. Throughout the year coat the metal using a non-abrasive metal protector to help displace moisture, remove contaminants, and shield the metal. World Cat recommends high quality sealants such as Boeshield T-9™ developed by Boeing™ Aviation. If you cannot find it locally call PMS Products Inc. at 800-962-1732.

Bilge Compartments

Routinely check the condition of the bilge compartments in your boat. This will help identify potential problems and eliminate odors associated with stagnant water and the buildup of residue. Clean the compartments using a fresh-water rinse. This will also enable you to check the function of your drain system and the operation of the bilge pumps.

7.8 Cockpit Drains

All World Cats have four drains located in the cockpit, two on both the starboard and port sides. These drains are designed to quickly evacuate the cockpit should the boat become swamped. Flushing these drains routinely will ensure the safety of your crew and vessel, as well as, eliminate the potential for odors associated with fish residue. These drains are evacuated through the scuppers located on the hullside. Each scupper has a rubber flap to prevent water from entering the boat. Check this material occasionally to keep them free of debris and in good working condition.

7.9 Winterization

Routine maintenance checks should be performed prior to each trip in accordance with Chapter 7, but a broader analysis should be done before winterizing your catamaran and prior to the first trip of the season. If your local climate does not require winter storage, complete the following steps at least annually to ensure the safe operation of your boat.

- Do not leave loose items or personal effects onboard during storage. Remove all trash and debris prior to cleaning the boat.
- Before storage clean the boat thoroughly, including exterior surfaces, fishboxes, livewells, and thru hull fittings. If possible leave lids open slightly to allow fresh air exchange.
- Remove the garboard drains and store the boat with the bow up to allow drainage.
- Inspect all electrical connections and the operation of pumps or other electrical devices. Perform repairs if necessary. Coat electrical panels with an anti-corrosive spray, available from your dealer.
- Inspect the batteries and charge fully to prevent damage during storage. Disconnect the cables and apply a coat of grease to the terminals to prohibit corrosion.
- Inspect all plumbing components and connections to prevent leaks. Replace any damaged hoses.
- Drain all lines and devices to prevent damage from freezing.
- Lubricate valves to maintain proper operation. Use the manufacturers recommendations for portable and marine heads
- Inspect fuel system components and replace fuel/water separators. You can keep the system fuel but do not overfill, and use a fuel additive to prevent condensation.
- Lubricate hinges and coat all metal surfaces with Boeshield T-9™ or other metal protector. Tighten down hardware if necessary.
- Inspect caulking around hardware, windows, hatches, etc. to prevent water damage. Normal use will break down sealants and can lead to costly repairs if not maintained.
- Remove or cover all electrical devices to prevent damage from UV rays. The rays will cloud electrical displays and make them hard to read.
- Remove cushions and store indoors to prevent damage.
- Winterize the engines and controls per manufacturers recommendations and inspect all connections, filters, and parts thoroughly. Replace parts as needed.

7.10 Maintenance Schedule

Maintenance	Each Use	Weekly	Monthly	Each Season	Yearly	As needed
Clean hull below the waterline				X		X
Bottom paint the hull					X	X
Check/Replace Sacrificial Anodes			X			X
Wash boat hardware and canvas	X		X			
Wax exterior gelcoat				X		X
Clean & protect hardware						X
Clean exterior upholstery	X					X
Clean cabin & interior upholstery						X
Flush engines with fresh water	X					
Spray metal components in bilge			X			
Clean bilge				X		X
Check bilge for leaks	X		X			
Inspect steering & controls	X					
Inspect fuel systems for leaks	X					
Replace fuel filters				X	X	X
Lubricate fuel fill O-rings			X			
Inspect fire extinguisher			X			
Test bilge pump auto switches			X			
Check battery electrolyte & service			X			
Check proper functioning of Pumps	X					
Replace pumps					X	X
Replace gaskets						X
Inspect & operate thru-hull valves			X			
Test & inspect AC electrical system & shore power cord			X			X
Windlass & Foot switches			X			

7.11 Maintenance Log

Service Date	Engine Hours	Dealer	Service / Repairs

7.12 Lewmar Maintenance

LEWMAR

DECK SWITCH SERVICE UPDATE

JUNE 2011

Overview

Electric deck switches operate in a hostile environment and are subject to salt water, extremes of temperature, direct sunlight and UV effect. They are also susceptible to wear and tear following repeated use and can in some instances suffer accidental damage during boat operations. It is therefore recommended that regular visual and functional inspection of the switch, the circuitry and the equipment being controlled is carried out by a competent qualified person on a regular basis.

If any defects are noted on the switch (see point 2.0 below), replacement is mandatory so as to avoid the possibility of a malfunction. It is further recommended that an item of this nature is not intended to remain in service forever. The lifespan will depend upon the weather and UV conditions to which the switch is exposed as well as the amount of use. Therefore, a service lifespan of 3 to 5 years from date of purchase can be expected, after which time it should be replaced. Shorter lifespans could be experienced and the following inspection recommendations are therefore important in ensuring continuing safe operation.

Inspection

- 1.0 The deck switch and the system it controls should be fully tested in a 'No Load' condition prior to full functional operation as per it's design purpose, before every trip, activity or task. Only after the skipper has satisfied themselves of the safe and functional operations should the equipment be used.
- 2.0 The deck switch should be inspected pre-departure or use paying particular attention to the following:
 - 2.1 Ensure there is no visible damage to the switch
 - 2.2 Ensure there is no noticeable wear to the switch, it's housing, it's button or fixings
 - 2.3 Ensure the rubber membrane over the switch is not sticky or has any deposits or residue from cleaning fluids or other prohibited materials
 - 2.4 Ensure the rubber membrane over the switch does not show any signs of cracks, splits or signs of degradation. This includes a change in colour from shiny to a matt finish
 - 2.5 The main switch housing should not have any visible chips or cracks
 - 2.6 The switch should have a smooth positive feel with a distinct click that can be felt at the point of operation
 - 2.7 There should be no signs of water ingress on any part of the switch assembly
 - 2.8 Ensure that the fixings screws and seal to the deck bulkhead or coach roof are secure, and remain effective in both securing the switch and preventing water ingress
 - 2.9 The switch should not feel spongy and should not make a squelch or bubbling noise due to water ingress when depressed and operated

DECK SWITCH SERVICE UPDATE

JUNE 2011

NOTE

If any of the points highlighted in 2.0 through to 2.9 are detected during inspection, the deck switches should not be used and should be replaced.

3.0 On an annual basis the deck switch should be removed by a qualified electrical technician to carry out the following:

3.1 All the checks detailed in 2.0 – 2.9 of this product service update

3.2 Inspect the underside of the deck switch for signs of corrosion, damage or water ingress

3.3 Inspect the wiring for signs of loose connections or corrosion

3.4 In open circuit mode (OFF) condition the resistance should be checked for a recording on the test meter beyond measurement to confirm no electrical connection.

3.5 In closed circuit mode (ON) condition, the resistance should be less than 3 Ω (ohms)

3.6 If the switch shows any signs of excessive wear, degradation in it's action, water ingress or loss in it's electrical resistance properties, it should be changed immediately

Additional Guidance

4.0 It is the responsibility of the skipper to ensure that crew members are trained in the operation of powered deck equipment and use it in a safe and appropriate way within it's designed operating parameters. This includes what to do in an emergency.

4.1 It is the responsibility of the skipper to ensure that crew members are appropriately briefed on all three methods of equipment isolation in event of emergency, i.e :-

4.1.1 The switch itself and it's operation

4.1.2 The circuit breaker on main panel

4.1.3 The main battery isolation

4.2 Crew briefings should always cover the following issues pertaining to deck switch operated equipment: -

4.2.1 Safe operation of any powered deck equipment.

4.2.2 What to do in the event of an emergency

4.2.3 What not to do in event of emergency

4.2.4 A practical demonstration of the effective isolation of deck equipment as highlighted in point 2 above

4.3 Deck switches are designed to be used in conjunction with Lewmar equipment only. If they are to be used for the powering of any other electrical equipment the intended use should be checked against the specification of the switch.

4.4 Deck switches should only be operated with fingers, bare feet or soft soled shoes.

DECK SWITCH SERVICE UPDATE

JUNE 2011

4.5 Switches should be left with the lid closed to minimise environmental degradation and the potential for accidental operation.

4.6 Powered deck equipment should always be isolated when not in use to prevent accidental start up.

4.7 The instructions for the equipment being operated should always be read and followed.

4.8 Power washers should not be used on or near any switch.

4.9 It is acknowledged that deck switches will need to be washed down as part of a deck cleaning process. However, direct flow from a non pressure hose should not be aimed at the switch.

4.10 The deck switch itself should only be cleaned with a mild soap and washed off immediately with a light application of fresh water.

4.11 The following (non exhaustive) list of substances should not be applied, or used on or near any deck switch. Products include but are not limited to:-

4.11.1 Chemicals

4.11.2 Deck cleaners

4.11.3 Petroleum based fluids/cleaners

4.11.4 Deck polish

4.11.5 Deck

Specific Considerations for Winch Operation Manual B2303 Issue 7

Winch Operation

Please ensure that you thoroughly understand the operation and safety requirements of the winch before commencing the installation. Only persons who are completely familiar with the controls and those who have been fully made aware of the correct use of the winch should be allowed to use it. If there is any doubt of how to install or operate this unit please seek advice from a suitably qualified engineer.

- *Winches used incorrectly could cause harm to equipment or crew.*
- *Winches should be used with care and treated with respect.*
- *Sailing, like many other sports can be hazardous. Even the correct selection, maintenance and use of proper equipment cannot eliminate the potential for danger, serious injury or death.*
- *Lewmar winches are designed and supplied for line control in marine applications and are to be used in conjunction with appropriate clutches, cleats and other manual controls and stoppers.*
- *It is the unavoidable responsibility of the owner or master or other responsible party to assess the risk of any operation on the vessel.*

DECK SWITCH SERVICE UPDATE

JUNE 2011

Under no circumstances should any self tailing winch be used in self tailing mode for any lifting operation; rather suitable and adequate manual tailing should be arranged with proper means of manually cleating or stopping the hoist.

- Every winch should be installed with adequate means of manually cleating or stopping the loaded ropes.

Specific Considerations for Windlass Operation Manual 65001201 Issue 2

Windlass Operation

Classification Societies and Lewmar require that a vessel at anchor must have its rode held by a chain stopper or equivalent strong point at all times!

At all times it is the responsibility of the boat user to ensure that the anchor and rode are properly stowed for the prevailing sea conditions. This is particularly important with high-speed powerboats, because an anchor accidentally deploying while under way can cause considerable damage. An anchor windlass is mounted in the most exposed position on a vessel and is thus subject to severe atmospheric attack resulting in a possibility of corrosion in excess of that experienced with most other items of deck equipment. As the windlass may only be used infrequently, the risk of corrosion is further increased. It is essential that the windlass is regularly examined, operated and given any necessary maintenance.

Please ensure that you thoroughly understand the operation and safety requirements of the windlass before commencing the installation. Only persons who are completely familiar with the controls and those who have been fully made aware of the correct use of the windlass should be allowed to use it. If there is any doubt of how to install or operate this unit please seek advice from a suitably qualified engineer.

- Windlasses used incorrectly could cause harm to equipment or crew.
- Windlasses should be used with care and treated with respect.
- Sailing, like many other sports can be hazardous. Even the correct selection, maintenance and use of proper equipment cannot eliminate the potential for danger, serious injury or death.
- Lewmar windlasses are designed and supplied for anchor control in marine applications and are not to be used in conjunction with any other use.
- It is the unavoidable responsibility of the owner or master or other responsible party to assess the risk of any operation on the vessel.

Additional Information

- Lewmar recommends the use of appropriate Personal Protective Equipment and hands free communication equipment by any person going aloft, and only then where the person going aloft is properly trained in the use of that equipment and where there remain sufficient trained and experienced personnel on deck to ensure constant observation and the continued safe conduct both of the vessel and the hoisting operation.

7.13 Hurricane Preparedness

North Carolina MARINA / BOATYARD HURRICANE PREPARATIONS

NC Boating Industry Services (919) 715-7668 (919) 715-7777 fax

CUSTOMER CHECKLIST

Equipment To Be Kept On Board:

- chafing gear
- fenders
- two sufficient anchors with 300' or more oversized rode
- flashlight with spare batteries
- battery-operated radio

Check Monthly:

- exterior lights operable
- auto bilge pump operating (check battery)
- hatches are watertight
- power and electric gear operating
- engine battery charged
- flashlight battery charged
- radio batteries charged

To Do At A New Marina:

- learn marina approaches and basin
- learn the size and type of your mooring
- ensure mooring and lines are sufficient for all likely wind direction and velocity
- ensure mooring has enough weight and scope and is properly set
- learn your moorage lease and rental agreement responsibilities
- learn responsibilities for your boat's safety when a hurricane is approaching
- develop a plan for securing your vessel outside the marina if you plan to evacuate
- if evacuating, visit the site by boat and time the trip
- learn what possible delays you may encounter when evacuating (drawbridges, boat traffic etc.)
- photograph your boat and surroundings
- keep a list of all equipment on board

- ☒ keep a list of all equipment that will be removed during storm preparations
- ☒ keep a complete set of records for your boat at home
- ☒ give the marina operator the name and number of your absentee skipper
- ☒ give the marina operator a description of your boat, registration number and location

DOCKED BOAT PREPARATIONS

- ☒ strip all removable items, including spare rigging
- ☒ clear self-bailing cockpit drains
- ☒ close all through-hull fittings
- ☒ set chafing gear where lines will rub (chocks, cross lines, deck edge, dock edge etc.)
- ☒ remove portable fuel and oil storage containers
- ☒ remove ship papers
- ☒ shut off fuel tanks
- ☒ leave anchor light on
- ☒ leave auto bilge pump on
- ☒ check openings to ensure boat is watertight
- ☒ set and check storm anchors
- ☒ consider attaching 3 sets of bow and stern spring lines
- ☒ consider attaching lines to cleats at a 45 degree angle
- ☒ consider tying your boat between two piers or along a pier and anchored off one side

MOORED BOAT PREPARATIONS

- ☒ Make Plans To Have Someone Pick You Up From Your Boat Before The Storm Arrives
- ☒ strip all removable items, including spare rigging
- ☒ clear self-bailing cockpit drains
- ☒ close all through hull fittings
- ☒ remove portable fuel and oil storage containers
- ☒ remove ship papers
- ☒ shut off fuel tanks
- ☒ leave anchor light on
- ☒ leave auto bilge pump on
- ☒ check openings to ensure boat is watertight
- ☒ use storm pennants to increase scope
- ☒ attach chains directly to pennants instead of swivels
- ☒ add an emergency catenary weight at the vessel end of the chain
- ☒ use double or triple chafe protection
- ☒ use chafing gear over entire length of pennants
- ☒ use two pennants
- ☒ if no permanent mooring is available, use two storm anchors at 45-degree angles

TRAILERABLE BOAT PREPARATIONS

Store in a garage:

- ☒ strip all removable items, including spare rigging
- ☒ clear self-bailing cockpit drains
- ☒ close all through-hull fittings
- ☒ remove portable fuel and oil storage containers
- ☒ remove ship papers
- ☒ shut off fuel tanks
- ☒ leave auto bilge pump on

2018 World Cat Glacier Bay Edition 2770/2780 Owners Manual

☐ check openings to ensure boat is watertight

☐ _____

☐ _____

☐ _____

If no garage is available:

☐ secure trailer to a sturdy object

☐ let half the air out of the trailer tires

☐ put wood blocks between the frame and axle

☐ take out the drain plugs

☐ cover with tarp

☐ use tie-downs

☐ _____

Make Plans To Have Someone Pick You Up From Your Boat Before The Storm Arrives

☐ strip all removable items, including spare rigging

☐ clear self-bailing cockpit drains

☐ close all through-hull fittings

☐ remove portable fuel and oil storage containers

☐ remove ship papers

☐ shut off fuel tanks

☐ leave auto bilge pump on

☐ check openings to ensure boat is watertight

☐ use 3 or 4 substantial anchors and good tie rope

☐ tie your boat high on the mainland to a substantial tree or similar structure

☐ do not tie parallel to the bank

☐ keep a navigable passage at your stern to allow other boats passage

☐ use enough line to allow for storm surge

☐ leave enough room between your boat and others to allow for swing

☐ take valuables off

☐ _____

Chapter 8: Warranty
8.1 2018 MODEL YEAR LIMITED WARRANTY



2018 MODEL YEAR LIMITED WARRANTY

Congratulations on the purchase of your World Cat product. We want you to have years of pleasure and fun aboard your World new boat. This document is your Limited Warranty. It describes the terms and conditions of the warranty agreement between us. It applies to all World Cat Products sold under the World Cat, Glacier Bay and Carolina Cat brands manufactured beginning with the 2018 Model Year. Your Model Year is identified by the Hull Identification Number ("HIN"), which is unique to every boat and located on the stern.

It is important to understand what a limited warranty does. It is an agreement between you and World Cat that your vessel will be free from substantial defects in material and workmanship for a specified length of time. However, if a defect does occur, you and World Cat agree that you will allow World Cat to repair it or, at our discretion, replace it as set forth herein. All products need repairs and maintenance from time to time, especially boats. Boats have a rough life in that they often go long periods between use, and when they are used, boats must perform in a difficult environment. Because of this, you should understand what your limited warranty does and does not cover and the terms and conditions that apply to it. Please note that there are disclaimers and limitations on page two of this Limited Warranty.

I. LIMITED WARRANTY

1. **Ten Year Limited Hull Warranty.** World Cat warrants that it will repair, or at its sole and exclusive discretion, replace any substantial defect in material or workmanship in the hull (defined as the one-piece fiberglass molded part that acts as the vessel's running surfaces) for the first ten (10) years following the date of purchase by the original retail owner. In the event that World Cat determines that your hull must be replaced, you agree to give us back the original hull and we will put a new hull on your boat. The replacement hull will be an upgraded model if the original model is no longer offered. Transfer of all accessories, including engines and electronics, will be at owner's expense.
2. **One Year Limited Material And Workmanship Warranty.** World Cat warrants that it will repair or, at its sole and exclusive discretion, replace any substantial defect in material or workmanship in any other parts or components of the boat that do not carry their own, separate written warranty, for a period of one (1) year following the date of purchase by the original retail owner. *Under no circumstances will World Cat warrant the engine, trailer or electronics.*

II. WARRANTY LIMITATIONS

THIS LIMITED WARRANTY DOES NOT COVER THE FOLLOWING:

1. Defects and/or damage arising out of engines transmissions, running gear and outdrives, metal plating or finishes, windshield breakage, and leakage due to seal and/or caulk shrinkage and/or normal wear and tear;
2. Defects and/or damage to gel coat or painted surfaces including, but not limited to, discoloration, fading, chalking, and/or osmotic blistering;
3. Defects and/or damages related to accessories, alterations, modifications or installations which were not part of the boat when shipped from the World Cat factory, and/or not authorized in writing by World Cat;
4. Damage and/or defects related to misuse, such as groundings and impacts with docks, pilings, navigation buoys, etc., accidents, lack of recommended maintenance, or improper trailering, blocking or lifting; and/or repairs by the owner or other persons without prior, written authorization from World Cat;
5. Use of the boat for competition, racing, or used for rental, business or commercial purposes without the prior written authorization of World Cat. Rental, racing, business or commercial use without prior, written authorization voids this warranty;
6. Defects and/or damage related to operation of the boat in violation of any Coast Guard regulations or other governmental laws, rules, or regulations;
7. Mildew, water damage, dry rot, staining or water absorption on interior materials and/or surfaces including but not limited to upholstery, cushions, cabinets or floor coverings, as a result of sustained exposure to humid conditions.
8. Galvanization and/or electrolysis or and other damage caused or contributed to by stray electrical current.
9. Defects, injury, costs or damages arising out the use of engines with a rated horsepower exceeding the maximum rated horsepower for each model as defined by World Cat Boats or as reflected on the capacity label.

III. CUSTOMER OBLIGATIONS:

1. You must sign and submit to World Cat the "LIMITED WARRANTY REGISTRATION FORM" within thirty (30) days of the date of delivery. Your dealer can do this for you, but it is up to you to request them to do so. **THE REGISTRATION FORM IS NOT A WARRANTY AND MAY NOT BE USED TO MODIFY OR CONFLICT WITH ANY TERMS OF THIS LIMITED WARRANTY;**
2. In the event you discover a defect, you must first notify the dealer from whom the boat was purchased within a reasonable period of time (not to exceed thirty (30) days) after you know or should know the defect exists;
3. World Cat will not be responsible for damage or to continue to repair or replace your boat or any part of it if your continued use prior to



2018 MODEL YEAR LIMITED WARRANTY

repair causes additional damage;

4. If you believe a claim has been denied in error or the dealer has performed the warranty repairs in an unsatisfactory manner, the owner must notify the World Cat Customer Service Department in writing within thirty (30) days of the repair attempt at the address listed below under "Notice." World Cat will then review your claim and take appropriate follow-up action.
5. You should keep records of all maintenance services. This record of proper maintenance may be required to determine warranty coverage on certain repairs and should be transferred to each subsequent owner. Please refer to the Owner's Manual that came with your boat for the proper maintenance procedures.
6. In the event a repair must be made at a factory authorized repair center or at the World Cat factory, transportation to and from the repair center shall be made at the Customer's expense and not at the expense of World Cat or its authorized dealer.

IV. TRANSFERABILITY

You can transfer the unexpired term of this limited warranty once to a new owner, provided that the transfer occurs during the first (5) five years after the date of purchase. A copy of the bill of sale from the original owner is required, as well as completion of the transfer form. The new owner must register the transfer of limited warranty within 30 days of purchase, by sending a written request to the address listed in the **Notice** section below along with a registration fee of \$395. World Cat reserves the right to reject any warranty transfer request for a boat that has been damaged, neglected or otherwise previously excluded from warranty coverage.

V. DISPUTE RESOLUTION

MANDATORY MEDIATION BEFORE SUIT

IN THE UNLIKELY EVENT WE CANNOT AGREE ON A RESOLUTION OF ANY ISSUE REGARDING YOUR BOAT AND/OR THE TERMS OF THIS AGREEMENT, OR IN FACT OF ANY ISSUE ARISING BETWEEN YOU AND WORLD CAT AND/OR A WORLD CAT DEALER, YOU AND WORLD CAT AGREE TO SUBMIT THE DISPUTE TO MEDIATION. MEDIATION IS A SETTLEMENT CONFERENCE BEFORE A TRAINED MEDIATOR THAT YOU AND A WORLD CAT REPRESENTATIVE WITH AUTHORITY TO RESOLVE OUR DIFFERENCES ARE REQUIRED TO ATTEND. WE WILL PAY THE COSTS OF MEDIATION, BUT WORLD CAT WILL NOT BE RESPONSIBLE FOR TRAVEL EXPENSES, OTHER COSTS OR ATTORNEY FEES. YOU AND WORLD CAT WILL SELECT A MUTUALLY AGREEABLE MEDIATOR TOGETHER. IF WE CANNOT AGREE, THEN ANY JUDGE WITH POTENTIAL JURISDICTION OVER THE CASE WILL SELECT THE MEDIATOR. THE MEDIATION WILL BE AT A MUTUALLY AGREEABLE LOCATION BUT IT WILL ALSO BE WITHIN 100 MILES OF THE PLACE OF PURCHASE UNLESS OTHERWISE AGREED. YOU AGREE THAT NO LAWSUIT OR ARBITRATION OR ADMINISTRATIVE ACTION OF ANY KIND FOR ANY TYPE OF DAMAGE OR REMEDY MAY BE REQUESTED OR FILED UNTIL THIS MEDIATION IS COMPLETED. THE MEDIATION SHALL BE COMPLETED WITHIN SIX MONTHS OF THE FIRST DEMAND BY YOU OR WORLD CAT TO MEDIATE UNLESS OTHERWISE AGREED.

VI. DISCLAIMER OF IMPLIED WARRANTIES

THIS IS A LIMITED WARRANTY. WORLD CAT MAKES NO WARRANTY, OTHER THAN AS CONTAINED HEREIN AND NO DECALS, PROMOTIONAL LITERATURE, BROCHURES, WEBSITE MATERIALS AND/OR PRE-DELIVERY SERVICE INSPECTION RECORDS/FORMS OR BROCHURES SHALL BE CONSTRUED AS ANY ADDITIONAL OR SEPARATE WARRANTY. TO THE EXTENT ALLOWED BY LAW, ALL WARRANTIES OF MERCHANTABILITY, WORKMANSHIP, SEAWORTHINESS OR FITNESS FOR A PARTICULAR PURPOSE ARE DISCLAIMED AND EXCLUDED.

VII. LIMITATION OF REMEDY AND EXCLUSION OF CERTAIN DAMAGES

ALL INCIDENTAL AND/OR CONSEQUENTIAL DAMAGES ARE EXCLUDED FROM THIS LIMITED WARRANTY. YOU AND WORLD CAT AGREE THAT YOUR SOLE AND EXCLUSIVE REMEDY UNDER THIS LIMITED WARRANTY (AND ANY IMPLIED OR STATUTORY WARRANTY) IS THE REPAIR OR REPLACEMENT OF THE VESSEL OR DEFECTIVE COMPONENT AS SET FORTH ABOVE. NO OTHER LEGAL OR EQUITABLE REMEDIES SHALL BE AVAILABLE TO YOU IN RETURN FOR THE BENEFITS OF THIS LIMITED WARRANTY.

VIII. PERFECT TENDER

A "PERFECT TENDER" MEANS THAT WE HAVE A RIGHT TO REPLACE YOUR BOAT IF, IN OUR DISCRETION, THE CLAIMED DEFECT REQUIRES REPLACEMENT AND WE AGREE TO DO SO IMMEDIATELY. FOR THESE PURPOSES, "IMMEDIATELY" MEANS WITHIN NINETY (90) DAYS FROM THE DATE YOU FIRST NOTIFY US THAT YOU BELIEVE THAT WE HAVE FAILED TO HONOR THIS LIMITED (OR ANY OTHER) WARRANTY AND/OR OTHERWISE FAILED TO PROPERLY REMEDY A SUBSTANTIAL DEFECT. IN THE EVENT YOU NOTIFY US IN WRITING, PER THIS AGREEMENT, OF A FAILURE ON OUR PART AND WE AGREE TO REPLACE YOUR BOAT WITH A NEW BOAT AS DESCRIBED IN YOUR ORIGINAL PURCHASE AGREEMENT, THEN IN THE EVENT YOU REJECT THE OFFER OF A NEW BOAT AND FILE A LAWSUIT OR OTHER LEGAL CLAIM, YOU AGREE THAT IN RETURN, WORLD CAT WILL BE NOT RESPONSIBLE FOR YOUR ATTORNEY FEES AND COURT COSTS. IF YOU HAVE FINANCED THE BOAT, YOU MUST EITHER PAY OFF THE AMOUNT YOU OWE BEFORE WE DELIVER THE NEW BOAT OR WE WILL ASSIST YOU TO SUBSTITUTE THE NEW BOAT AS COLLATERAL. WE ARE NOT RESPONSIBLE FOR PAYING OFF YOUR PRESENT BOAT.

IX.



2018 MODEL YEAR LIMITED WARRANTY

X. OTHER TERMS AND CONDITIONS

This limited warranty gives you specific legal rights, and you may also have other rights, which may vary from state to state. Some states and/or federal laws do not allow limitations to implied warranties or as to remedies or certain damages, so the above disclaimers and/or limitations may not apply to you.

World Cat will discharge its obligations under this warranty as quickly as possible, but we *cannot guarantee any specific completion date*. This is due to the potential complexity of the repair or the availability of parts from sources over which World Cat has limited control. You agree that the time for repairs does not include time spent waiting for parts or the time your boat may end up stored at our factory or at a dealer for your convenience or due to scheduling.

World Cat reserves the right to change or improve the design of its boats, without obligation to modify any boat previously manufactured. World Cat shall in no way be responsible for any repairs not PRE-AUTHORIZED by a World Cat Customer Service Manager or repairs performed by a repair shop not PRE-AUTHORIZED by a World Cat Customer Service Manager. "PRE-AUTHORIZED" means that we have a say in how the repairs are performed *before* they are performed.

XI. NO WAIVER OF THESE TERMS

The terms, conditions, limitations and disclaimers contained herein cannot be waived except by a management level employee of World Cat. Any waiver we give shall be in writing. Neither the dealer, nor any service, sales and/or warranty representative of World Cat are authorized to waive and/or modify these conditions, limitations and/or disclaimers.

XII. NOTICE:

All communications and notices from you and/or a new owner requesting a transfer of this limited warranty should be sent to: World Cat Customer Service, 1090 West Saint James Street, Tarboro, NC 27886 or faxed to 919-882-8035. You can also email us at: service@worldcat.com, but you must request an acknowledgment that our Customer Service Department actually received it.

Acknowledgment of Limited Warranty.

By signing below, you agree that you have read this limited warranty in its entirety and understands its terms and conditions. You acknowledge that you have received a copy of this limited warranty at or before the time of the sale.

WARRANTY REGISTRATION

Purchaser's Name

Purchaser's Phone Number

Purchaser's Street Address

Date of Delivery

Purchaser's City, State and Zip Code

Hull Identification Number

Purchaser's Email Address

Boat Model

Purchaser's Signature

Selling Dealer

Dealer's Sales Representative

Check one: Original Owner Second Owner

Please fax to (919) 882-8035 or email: service@worldcat.com

Chapter 9: 2770/2780 Operation and Schematics

9.1 Operation of Standard Equipment

9.1.1 Battery Layout and Management

The 2780 is equipped with three batteries, which are located in the aft battery compartment on the transom wall. A cranking battery is installed on each side, and a dedicated house battery is installed in the center. Wire leads run through the hull harness to the battery management panel which is located under the helm seat. See section 6.5 & 6.6.1 for information regarding the operation of this panel. The engine cranking leads run aft, through a hull rigging tube, The negative engine leads are connected to the common battery ground using a negative buss also located in the aft rigging compartment.

The house battery provides the power for a majority of your DC accessories. The main battery lead runs to the "HOUSE" switch on the battery management panel. From there current is routed to the dash and circuit breaker through the 50 amp "DC Main" breaker located in the left side of the battery management panel. During normal operation this breaker can remain in the "ON" position, and the "HOUSE" switch can be used to control the flow of current. The main ground for all DC accessories is tied into the common ground on all batteries. For a detailed drawing of the battery management panel connections, see section 10.2.4.

9.1.2 Additional Emergency Parallel

As an additional feature, the 2770/2780 management panel contains a secondary "EMERG PARALLEL" switch. It allows you to mechanically link the starboard "cranking" battery to the house battery. Furthermore, engaging both "EMERG PARALLEL" switches will connect all three batteries into a single bank. The switches should remain in the "OFF" position when not in use. To prevent voltage spikes or drops which can damage electrical components, you should trip the DC Mains 1 breaker prior to cranking engines with the house battery in parallel. Once you are running, the breaker can be reset to allow the full alternator output to power the electronics. This is a safety feature and should not be used in-lieu of the VSR's to charge batteries while underway. Doing so, could result in premature battery failure and increases the risk of electrical failure while at sea.

9.1.3 Bilge Pumps / Float Switches

Your 2780 is equipped with two 1500 GPH bilge pumps located aft and two 500 GPH pumps forward. Each pump is connected to a float switch which automatically triggers the pump when water comes to rest in the bilge. The float switches are connected to the battery management panel through the hull harness and receive power from the breakers on the right side of the panel. These breakers are constantly energized and ensure the safety of your boat even when the battery switches are in the "off" position. The pumps can be manually engaged using the switch at the dash.

The aft bilge pumps are located behind the aft rigging compartment and can accessed through the inspection plates in the motorwell, forward of the engines. The forward bilge pumps are located under the inspection plate in front of the head in the portside cabin and under the starboard side storage liner .. The wiring for these pumps is secured to the centerline stringer which is visible from the hatch. Inspect the operation of your bilge pumps and their connections at least annually. To do so, activate the pump by removing the pump from the base and flipping it upside down. Then check the operation using the manual switch. Keeping your bilge areas clean can also help extend the life of your pump.

9.1.4 Anchor Windlass

World Cat provides an anchor windlass manufactured by Simpson Lawrence™. This feature includes the windlass, an anchor, anchor rope, and chain which is matched to your vessel's size. The rocker switch to control the windlass is mounted at the helm, and foot switches are installed at the windlass. The manufacturer's instruction manual is provided, in the "Owner's Portfolio", detailing their use.

The circuit breaker for the anchor windlass is mounted in the center of the battery management panel. The panel is connected to the "Stbd Start" battery switch. If you choose not to have the factory install your windlass, World Cat provides wires in the deck harness to allow for aftermarket installs. Regardless of type, a directional control solenoid and rocker style switch will be needed to add the aftermarket windlass. Please refer to the windlass's user manual for proper installation.

9.1.5 Freshwater System

The freshwater pump is mounted to the starboard hullside and can be reached by removing the battery management panel or the trash can compartment behind the sink. The pump is connected to the 20 gallon freshwater tank located in the hull forward of the starboard fuel tank. The tank is filled through a fitting located on the starboard side of the deck. Similar to residential well pumps, the freshwater pump pressurizes the system to 45 psi. then shuts down until the pressure drops below that level. Most owners leave the pump "on" throughout the day, and use the system when necessary. On the 2770/2780, the freshwater pump feeds the pull out shower located on the aft transom wall, freshwater wiper rinse, sink and the marine head. To view the layout of the freshwater system see section 10.2.4

9.1.6 Seacocks

Ball valves (seacocks) are installed on the water intake for both the livewell and raw water system. The seacock must be in the open position for these systems to work. When open, the handle will be parallel to the valve. In the closed position the handle is perpendicular to the valve (see picture below). World Cat recommends that the seacocks remain in the closed position when not in use, or when the boat is left unattended to prevent the vessel from taking on water due to a plumbing failure.



OPEN



CLOSED

9.1.7 Livewell System

The 2770/2780 has a 20 gallon livewell system. which is supplied by a dual purpose livewell pump. The pump is located in the port bilge compartment and can be reached through the inspection port in the motorwell. The wiring is secured to the pump using a tie-strap, and must be disconnected prior to removing the pump.

The livewell pump draws water through the strainer mounted on the inboard side of the port sponson. A sea-cock is installed between the pickup and the pump to allow you to seal the system between use, or in the event of a plumbing failure.

To operate the livewell, first verify that the seacock is open, then plug the bottom drain with the livewell plug supplied. When you have completed these steps, engage the livewell pump using the switch at the dash. Water will fill the tank until it is level with the overboard drain, which evacuates water through the hullside. When you have finished using the livewell, remove the water by removing the livewell plug from the bottom drain.

NOTICE

While underway, leaving your livewell seacock open could result in inadvertently filling your livewell. To prevent this, close the seacock when the pump is not in operation.

NOTICE

Operating the engines in reverse can cause excessive ventilation near the livewell intake, causing the pump to airlock. To prevent this, turn the pumps "OFF" prior to any continuous or high speed reverse operation. If your pump does becomes air locked, turn the pump "OFF" for 15 to 30 seconds to correct the problem.

9.1.8

Raw Water System

The raw water pump and strainer are mounted on the rigging wall in the port bilge compartment, which can be accessed through the motorwell hatch. The strainer is connected to a high speed pickup through the sea-cock located on the inboard side of the starboard sponson. The seacock must be open for the system to work. Similar to the freshwater pump, the raw water system is controlled by a pressure switch set at 45 psi. The pump will cycle on and off as needed to maintain this pressure. Most owners leave the pump "on" throughout the day, and use the system when necessary. On the 2770/2780, the raw water pump feeds the raw water outlet located under the livewell on the portside.. A wash down hose has been included with your boat to use with this system. To view the layout of the raw water system see section 10.2.4.

9.1.9 Marine Head

The 2770/2780 comes equipped with a marine head. The control panel for the head is located on the head instrument panel located under the cabin entry steps. Power is supplied to this panel through a 25 amp breaker located on the battery management panel.

Water is supplied to the system from the freshwater tank; therefore, to operate the toilet the freshwater system must be pressurized. A solenoid, installed near the head inlet, prevents water from filling the bowl prior to each use. The macerator pump, located at the rear of the toilet, removes waste from the bowl and pumps it into the 15 gallon holding tank.

WARNING

If the solenoid fails or becomes locked in the open position, shut off the supply system quickly and evacuate the bowl.

The holding tank is mounted in the port hull forward of the gas tank, it can be accessed by removing the tackle center under the livewell. This tank can be evacuated using the deck pump-out fitting located on the port side of the deck near the helm or by overboard discharge using the macerator pump and seacock supplied on your vessel. To access the seacock, remove the starboard cabin storage panel located under the mattress . Open the seacock and use the keyswitch on the head switch panel to evacuate the tank.

1.1.1.1 Initial Start Up

On each trip, prior to using the head, complete the following steps:

- Turn on the freshwater system.
 - Fill 1/3 of the bowl with water using the lower switch on the control panel
- Hold down the flush switch for 5 seconds to evacuate the bowl and refill with water.

1.1.1.2 Normal Use

Use the steps below for normal operation.

Hold the upper switch on the panel down for 5 seconds. This will purge the bowl and refill it with water. In the event of inclement weather or rough seas, use the lower switch to remove water from the bowl and prevent sloshing

!! CAUTION

Large quantities of waste or paper can clog the head and cause odor issues. To prevent this, flush often and if necessary perform an extra flush to purge the discharge line.

!! CAUTION

Do not dispose of foreign objects in the head. Doing so may damage the macerator pump or outlet hoses. Clogging or puncturing these lines will lead to odor problems.

1.1.1.3 Deck Pump Out

Upon returning, use the following instruction to empty the holding tank.

- Remove the cap from the deck pump-out fitting located on deck, outboard of the helm position.

Use the vacuum hose at the pump-out station to clean the tank, then remove the hose and replace the deck fitting.

1.1.1.4 Overboard Discharge

Use the following steps to discharge the contents of the holding tank overboard:

- Open the overboard discharge seacock. To access, open the inspection hatch installed in the port gunwale near the helm.
- Use the keyswitch located on the head switch panel to evacuate the tank.

Inspect the tank level and repeat step 2 if needed, otherwise close the discharge seacock.

For more instructions on operation, winterization and troubleshooting the marine head, see the Jabsco™ manual supplied in your "Owner's Portfolio".

!! CAUTION

Discharging waste in inland waters and some coastal areas is illegal. Check with local and state authorities in your region to determine the proper method for waste disposal.

9.1.10 Stereo

Your 2770/2780 is equipped with a stereo unit. The unit is mounted on the helm bulkhead. Two speakers are mounted in the cockpit, and the remaining two are installed inside the cabin birth... Power is supplied to the stereo through an accessory fuse block therefore, the "house" battery switch must be in the "on" position to use the unit.

9.2 Maximum Horsepower Rating: **Twin 150 4-Stroke HP (300 HP total)**

Chapter 10: Operation and Schematics

10.1 Operation of Optional Equipment

10.1.1 Shorepower/Charger/Microwave-Package

Combined with the battery management system, this system helps ensure that your vessel will be ready to fish whenever you are. The charger is located on the bulkhead under the livewell on the portside to access open the hatch located beside the livewell compartment. The shore power package includes a shore power inlet and cord set (30 Amps), AC distribution panel, microwave, five (110V) receptacles and battery charger. Following are instructions on the function and proper use of these accessories.

1.1.1.5 Connecting Shore Power

- The shorepower inlet is located on the outboard vertical wall of the starboard motorwell. Use the following steps to help protect your vessel and yourself.
- Before connecting the cord set, turn the "AC Main" breaker and all accessory breakers to the "OFF" position. The breakers are installed on the AC panel located on the upper galley cabinet in the cabin.
- Connect the cord set to the boat first, by plugging it into the receptacle and tightening the trim ring.
- Once these steps are completed, attach the cord set to the outlet supplied by the marina.
-

1.1.1.6 Disconnecting Shore Power

- To disconnect the shore power cordset, reverse the procedure above.
- Turn the "AC Main" breaker and all accessory breakers to the "OFF" position.
- Unplug the cordset from the marina supplied out-let, then unscrew the trim ring and remove the cord set from boat's inlet.

10.1.2 Microwave

Microwave is located in the portside cabin berth. It operates exactly like a residential unit, and functions only when you are connected to ship or shore power. Please refer to the Microwave user manual for proper operation.

10.1.3 AC Panel

The AC distribution panel is installed in the cabin behind the helm area. This panel houses the circuit breakers for the AC system and its accessories. The panel also contains a reverse polarity indicator. Reverse polarity occurs when the AC power lead (black) and the AC grounded lead (white) are reversed. This can destroy appliances and create the potential for electric shock. Therefore, after attaching the shore power, turn the "AC MAIN" breaker "ON" first and inspect the reverse polarity indicator. If the LED indicator remains unlit, you can engage the remain-ing accessory breakers. If the indicator light turns red, immediately turn "OFF" the "AC MAIN" breaker and disconnect the shore power. Notify the marina regarding the issue and have a trained electrician inspect your boat to determine if any damage has been sustained by the electrical system.

10.1.4 Cruiseair Climate Control Package

World Cat provides an optional Cruiseair® 8,000 BTU heating/ cooling unit with vents to the cabin and cockpit for your comfort. The heating/air conditioning unit is mounted under the starboard cabin storage panel located under the mattress. It can be accessed by remov-ing the storage panel above the unit. The filter control panel is located in this bulkhead. Follow these startup guidelines before each use of the unit:

- 1. Verify that the seacock located in the starboard aft bilge compartment is open.**
- 2. Using the guidelines provided, energize the AC panel using the generator of shore power connection and engage the corresponding circuit breaker.**
- 3. Using the control panel, energize the climate control unit and select the operating mode and desired temperature using the selection tools. This will engage the raw water pump located in the port aft rigging compartment.**
- 4. Once the unit is running, inspect for water flow through the system by checking the thru-hull located on the port sponson (see Thru-Hull drawing in section 10.2.4). If water is not flowing, shut down the unit immediately to prevent damage. Then have your dealer inspect the system.**

Similar to a residential system, the filter units must be replaced at regular intervals to ensure proper operation. Use the manual provided in your "Owner's Packet" to obtain requirements for service, and to get recommendations on usage.

10.1.5 Refrigerator

A DC refrigerator is installed in the cockpit under the starboard sink. The refrigerator is similar to any dorm style unit. The unit is hard wired to the battery management panel, and will operate off battery power while the "HOUSE" battery switch is in the "ON" position.

10.1.6 Cooking Package (propane Grill)

Magma Newport Gourmet Series Gas Grill - Grills quickly, evenly and disassembles easily for cleaning. Uses inexpensive disposable 1-lb. propane cylinders. Remove from storage and place in mounting brackets on top of gunnel. Make sure the unit is secure before lighting.

10.1.7 Teleflex™ Power Assist Unit

The power assist unit provides automobile like steering on your catamaran. The unit is installed under the starboard cabin storage panel located under the mattress. It can be accessed by removing the storage panel above the unit. The power for the unit is connected to both port and starboard key switches.

10.1.8 Heavy Duty Stainless Steel Lifting Eye

The lifting eye option allows the boat to be lifted from the stern (port & starboard transom eyes) as well as the heavy duty stainless steel lifting eyes located on the port and starboard bow deck. When lifting from these points your straps or cables must be attached so they are vertical and in line above these four points. Spreader bars are REQUIRED when lifting from a single point. The lifting eyes are a TEMPORARY means for transferring your boat to and from the water. These are not designed for storage on divats or lifts.

10.2 System Diagrams

10.2.1 Access Plate and Rigging Tube Diagram

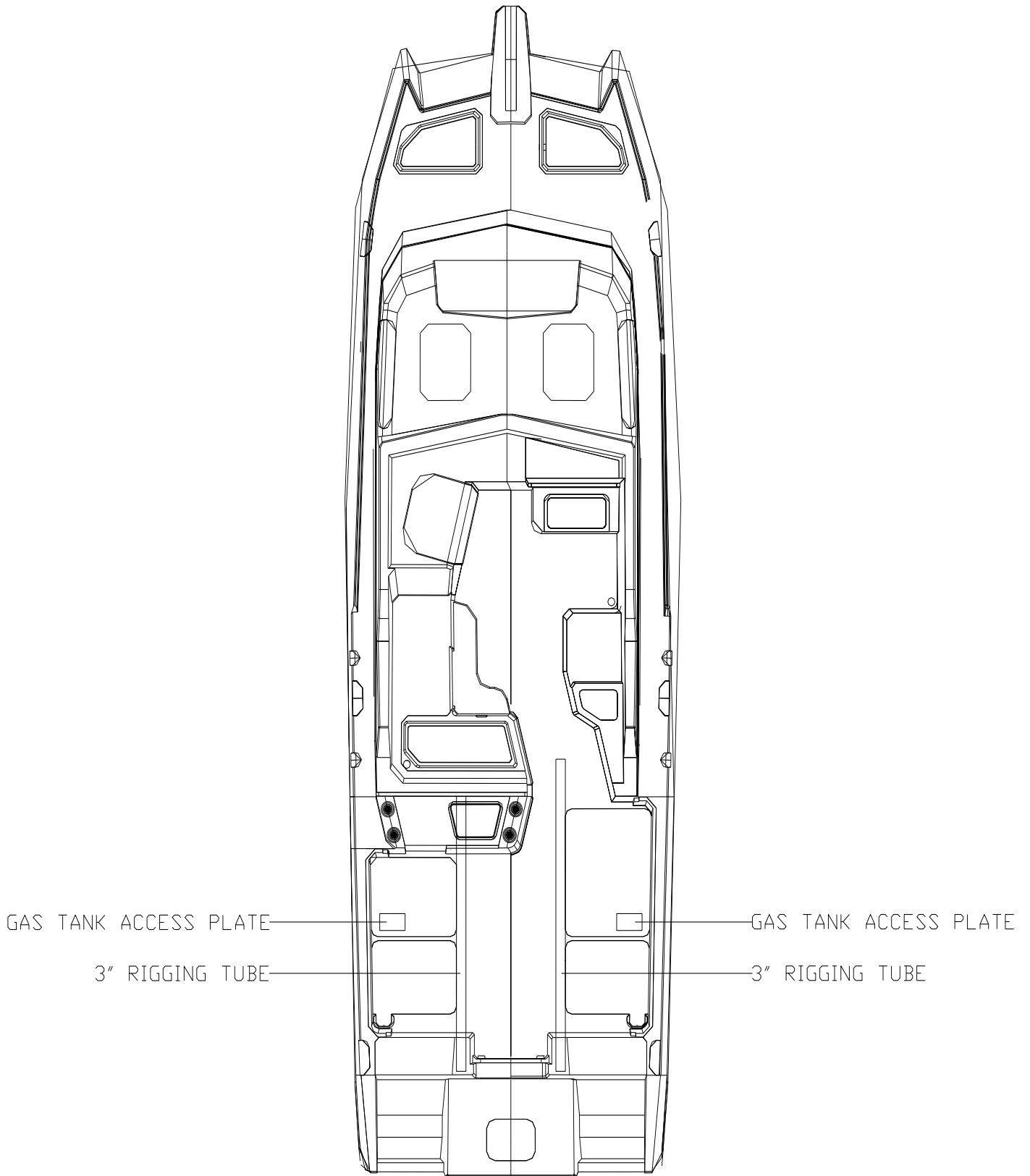

10.2.3 Water Systems Diagram

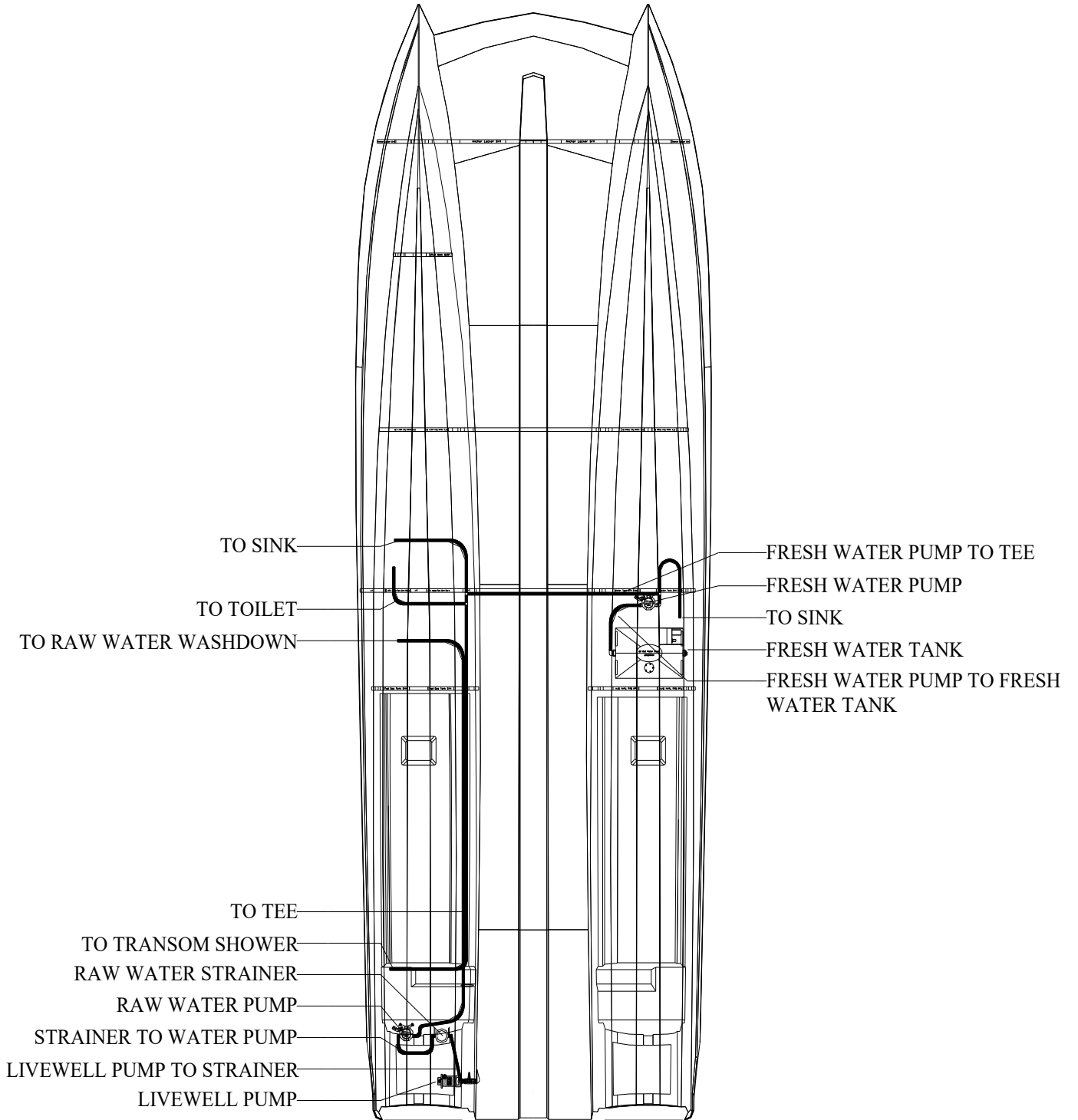

10.2.2 Hull Wiring Diagram

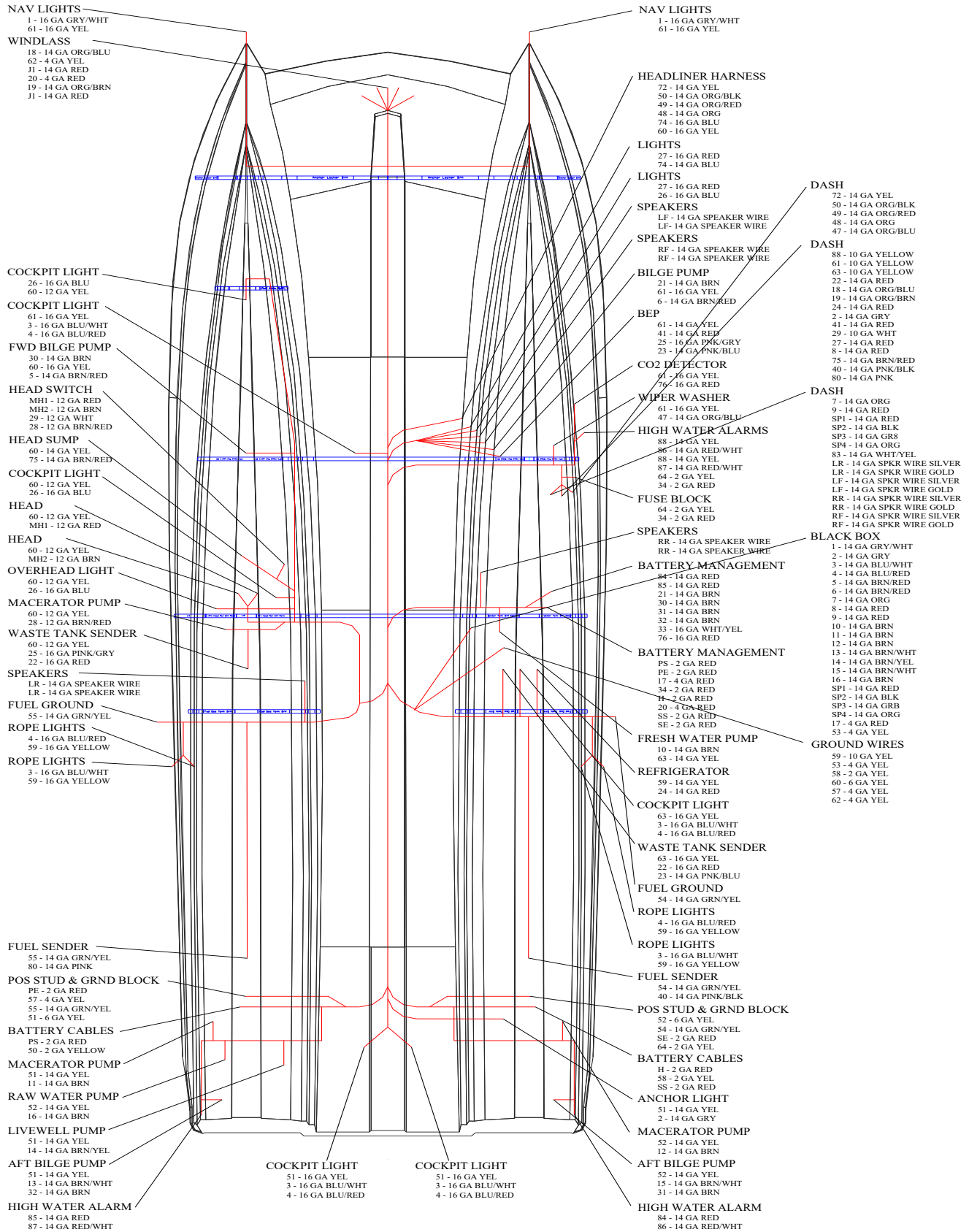

10.2.4 Thru Hull Diagram

T-HULL	DESCRIPTION	T-HULL	DESCRIPTION
A	ANCHOR LOCKER RECESS	I	COCKPIT
B	FWD BILGE	J	SINK
C	SHOWER SUMP	K	WATER TANK VENT
D	L-LOUNGE TUB	L	SEATBOX DRAIN
E	LIVEWELL	M	GARBOARD
F	WASTE TANK VENT		
G	FLOOR FISHBOX	T-HULL	OPTIONAL DESCRIPTION
H	AFT BILGE	N	Optional/Cruise/Climate Control Package

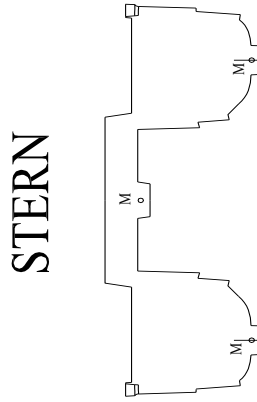

PORT

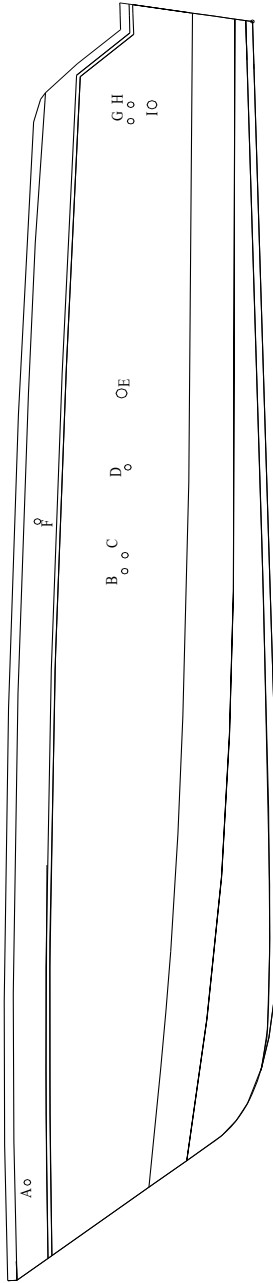

STBD

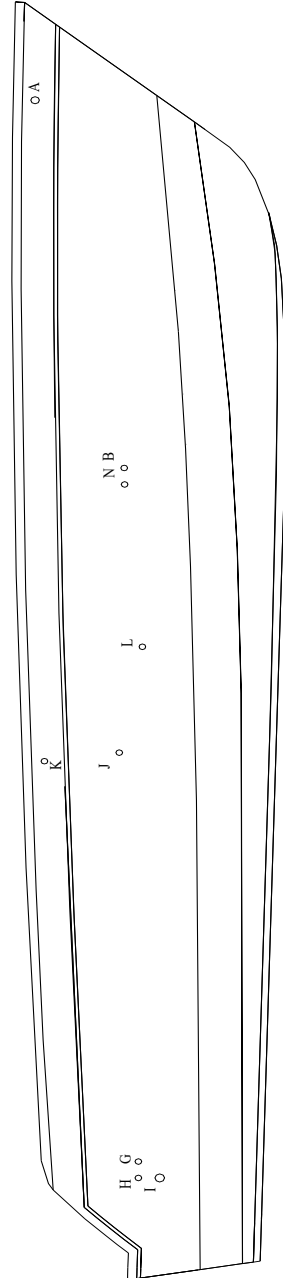

Chapter 11: Spare Parts

PLEASE NOTE: PARTS / COLORS / EQUIPMENT ARE SUBJECT TO CHANGE. CONTACT YOUR LOCAL DEALER FOR THE LATEST INFORMATION

Service Class	Part Number	Description
Electrical & Lighting		
	20170274	12VDC Outlet for Lighter Plug
	20200364	2.75" LED Light (Red/Wht) w/Deutsch
	20300381	2740/2770/2780/255/23DC Hardtop Panel (Pacer Marine)
	20156969	2770 Battery Panel Cabinet (Arctic White) (NEW PART) 3/22/2013
	20156970	2770 Electronics Dash Panel (NEW PART) 3/22/2013
	20156971	2770 Hardtop Closeout (Arctic White) (NEW PART) 3/22/2013
	20300384	2770 Switch Panel (Pacer)
	20300373	2770/255 Head Panel (Flush, Overboard Discharge)
	20170893	30A 125V Easy Lock Inlet SS Shore Power w/Enclosure
	20200332	4" LED Light (Red/Wht)
	20170956	Alarm-Co2 Carbon Monoxide





These parts should be installed by a certified Glacier Bay dealer. Installation by a non-authorized 3rd party may result in improper performance and create safety concerns. Please contact your local, authorized, Glacier Bay dealer to buy these parts at the same price.

Price and availability subject to change.

Service Class	Part Number	Description
	20200297	Atwood LED Mast Light (24") - S/S Base
	20171503	Battery Post Fuse (80A)
	20156841	Battery Tray (Group 27) - Narrow Width - S/S Rods
	20170277	BEP Negative Buss Bar HD (300A/4-Pole)
	20190177	BEP Positive Stud
	W7013397	BEP Ultra Sonic Sender for 15gal Waste Tank (290EC, 290CC, 320CC, 2740, 2770)
	20170922	Bilge Alarm System (2pcs)
	20190503	Blue Sea Charge Relay (ACR)
	20173489	Bluetooth Dongle - Sirius Input (Fusion Stereo)
	26500249	Cabin Receptacle
	20173417	Coastal Plus Wiper Motor 3 1/2" Shaft

These parts should be installed by a certified Glacier Bay dealer. Installation by a non-authorized 3rd party may result in improper performance and create safety concerns. Please contact your local, authorized, Glacier Bay dealer to buy these parts at the same price.

Price and availability subject to change.

Service Class	Part Number	Description
	20151493	Day/Night (3" Rnd) White - w/Battery Backup Solar Mini-Vent
	26500388	Dometic Digital Display (White)
	20170360	Dual Direction Ctrl 12V (PM)
	20173490	Fusion Marine 700 Series Internal Ipod Receiver N2K (w/ Amphenol Connector)
	20173501	Fusion Stereo Remote
	20300372	Glacier Bay 2770 Battery Mgmt Panel - Blue Sea 365
	20170361	Guarded Rocker Switch
	26500480	Isotherm CR42 S/S AC/DC Refrigerator (Left-Hinge)
	20173510	JL Audio 6.5 Speaker (Titanium w/ Sport Grill)
	20200283	LED Bow Lights (PR)
	20200291	LED Overhead Light (2.75")

These parts should be installed by a certified Glacier Bay dealer. Installation by a non-authorized 3rd party may result in improper performance and create safety concerns. Please contact your local, authorized, Glacier Bay dealer to buy these parts at the same price.

Price and availability subject to change.

Service Class	Part Number	Description
	20200285	LED Stern Light (48")
	20170371	Lewmar ProFish 700 Windlass - Freefall
	20170874	Lewmar Windlass Up/Down Foot Switches (Black)
	26500467	Microwave Cabinet Hold Board (2770)
	26500501	Microwave-Current Model .7 CU 120v/60Hz, UL (Prefer Black)
	26500250	Outlet Box
	20300379	Pacer Tank Monitor Panel (Waste/FW) (Replaces BEP Monitor)
	20173457	Panel ELCI 120V 30A 2P 30mA Toggle Breaker
	20200286	Pole Light Base, Black SS w/ Locking Collar (2-Pin Light)
	20173375	ProSafe Galvanic Isolator (30A)
	20173426	ProSport 20 Plus 3-Bank Waterproof Charger (20A, 50/60Hz 90-135VAC)







These parts should be installed by a certified Glacier Bay dealer. Installation by a non-authorized 3rd party may result in improper performance and create safety concerns. Please contact your local, authorized, Glacier Bay dealer to buy these parts at the same price.

Price and availability subject to change.

Service Class	Part Number	Description
	26500248	Receptacle GFCI
	20170913	Ritchie Compass (Small Profile)
	20173431	Sony AM/FM Antenna w/ Amp
	20200277	Spreader Light (Flush Mount)
	20171501	Terminal Fuse Block
	20157087	Underwater Light (Blue LED)
	20200359	Vimar 3M Faceplate (Chrome)
	20200362	Vimar Mounting Box 3M
	20200361	Vimar Mounting Frame 2M
	20200360	Vimar Mounting Frame 3M
	20200356	Vimar On - Off Switch

These parts should be installed by a certified Glacier Bay dealer. Installation by a non-authorized 3rd party may result in improper enforcement and create safety concerns. Please contact your local, authorized, Glacier Bay dealer to buy these parts at the same price.

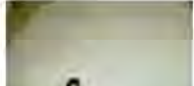
Price and availability subject to change.

Service Class	Part Number	Description
	26500252	Weatherproof Cover Plate
	26500005	Weekender Breaker AC Panel 6 Way w/ Double Pole
	20160665	Wiper Blade (18")
	20170911	Wiper Controls Backing Plate
	20170880	Wiper Fluid Reservoir (4 liter)
	20163481	Wiper Motor Wedge (2770)
Fiberglass		
	26003399	Laminated Anchor Locker Lid - Port (GB 2700's)
	26003400	Laminated Anchor Locker Lid - Stbd (GB 2700's)
	26003502	Laminated Berth Storage Lid (Fwd) (2770)
	26003503	Laminated Berth Systems Lid (Aft) (2770)
	26003440	Laminated Deck Cap - Port (2770)





These parts should be installed by a certified Glacier Bay dealer. Installation by a non-authorized 3rd party may result in improper enforcement and create safety concerns. Please contact your local, authorized, Glacier Bay dealer to buy these parts at the same price.

Price and availability subject to change.

Service Class	Part Number	Description
	26003441	Laminated Deck Cap - Stbd (2770)
	26003492	Laminated Deck Plate - Arctic White (8" x 10")
	26003393	Laminated Fishbox Lid - Port (2740)
	26003394	Laminated Fishbox Lid - Stbd (2740)
	26003445	Laminated Gas Tank Lid - Port (2770)
	26003446	Laminated Gas Tank Lid - Stbd (2770)
	26003443	Laminated L-Lounge Seat Lid (2770)
	26003561	Laminated Step-Lower (2770/80)
	26003560	Laminated Step-Upper (2770/80)
	26003462	Laminated Sump Access Plate (2770)
	26000420	Laminated Swim Step - Arctic White (2600)

These parts should be installed by a certified Glacier Bay dealer. Installation by a non-authorized 3rd party may result in improper enforcement and create safety concerns. Please contact your local, authorized, Glacier Bay dealer to buy these parts at the same price.

Price and availability subject to change.

Service Class	Part Number	Description
	26000421	Laminated Swim Step Lid - Arctic White (2600)
Fuel System		
	20180013	1/4 PT X 3/8 HB, Brass
	20160328	1/4 PT X 3/8 HB, Brass 90 deg.
	20220083	Attwood FDV Fuel Demand Value (No-Antisiphon)
	20163465	Attwood Inlet Control Valve (EPA Diurnal)
	20163464	Attwood Pressure Relief Deck Fill (Angled Zamak/Chrome)
	20163373	Fuel Filter Mounting Plate
	20140102	Fuel Hose 1 1/2" (50'/RL)
	20140103	Fuel Hose 3/8" (250'/RL)
	20140104	Fuel Hose 5/8" (250'/RL)
	20220081	Gas Tank 90 Gal EPA Non-Perm Plastic Tank (Port/Stbd)











These parts should be installed by a certified Glacier Bay dealer. Installation by a non-authorized 3rd party may result in improper performance and create safety concerns. Please contact your local, authorized, Glacier Bay dealer to buy these parts at the same price.

Price and availability subject to change.

Service Class	Part Number	Description
	20220039	Tank Hold Down Brackets (Inca J-Hooks)
	90441543	Yamaha Fuel Filter/Water Separator
Gel coat		
 Aqua Mist Green	20040120	Gel Ext Ashland "Aqua Mist" (Awlgrip H4365 Match) (PL357)
 Platinum Grey	20040132	Gel Ext Ashland "Platinum" (RAL-7040 Window Gray) (PL357)
 Arctic White	20040039	Gel Ext Ashland "SR Arctic White" Gel (120105)
 Arctic White	20040039	Gel Ext Ashland "SR Arctic White" Gel (120105)
 World Cat Exterior	20040037	Gel Ext Ashland "World Cat Exterior"(164922)
 Sapphire Blue	20040098	Gel Ext Ashland NCP "Sapphire Blue" (RAL-5003) (PL357)
 Ice Blue	20040128	Gel Ext Ashland NRP "Ice Blue" (Sea Hunt Match) (PL357)
 Ice Blue	20040128	Gel Ext Ashland NRP "Ice Blue" (Sea Hunt Match) (PL357)
 Arctic White	20040090	Gel Int Ashland "SR Arctic White" Gel (11 Series)
Graphic & Logos		









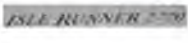

These parts should be installed by a certified Glacier Bay dealer. Installation by a non-authorized 3rd party may result in improper enforcement and create safety concerns. Please contact your local, authorized, Glacier Bay dealer to buy these parts at the same price.

Price and availability subject to change.

Service Class	Part Number	Description
	60690314	Flammable Warning Decal
	20690500	Fuel Fill Warning Label
	20690477	GB Wedge Tapered Graphic - Port (6" x 26' Black -55/ -055 / Light Gold Metallic -3130)
	20690478	GB Wedge Tapered Graphic - Stbd (6" x 26' Black -55/ -055 / Light Gold Metallic -3130)
	20690438	Glacier Bay 2.5" Black Waterline Strip w/gold (150'/RL)
	20690434	Glacier Bay Hullside Logo - 5" x 46" (Black)
	20690434	Glacier Bay Hullside Logo - 5" x 46" (Black)
	20690432	Glacier Bay Hullside Logo - 5" x 46" (White)
	20690435	Glacier Bay Walkthrough Logo - 2" x 18"(Black)
	20690436	Illegal to Dump/Trash Overboard
	20690384	Label Warning Entry Door

These parts should be installed by a certified Glacier Bay dealer. Installation by a non-authorized 3rd party may result in improper enforcement and create safety concerns. Please contact your local, authorized, Glacier Bay dealer to buy these parts at the same price.

Price and availability subject to change.

Service Class	Part Number	Description
	20690394	Label Warning Large Fishwell Lid
	20690385	Label Warning Small Hatch-Anchor
	20690377	Label, NMMA Certified-Domed
	20690475	Model Designator - Isle Runner 2770 (Black)
	20163358	NMMA Yacht Plate (Glacier Bay)
	20690484	PowerCat Group RTM Coverup (Crystal Cap Foam Backed, 1.5 x 2.25)
	60690302	Warning Label - Prop Helm
	60690301	Warning Label - Prop Transom
Hardware- Deck		
	20150232	12" Handrail W/ Studs, S/S Part
	20150320	18" Handrail
	20156916	2600 Swim Step Cover (Arctic White)

These parts should be installed by a certified Glacier Bay dealer. Installation by a non-authorized 3rd party may result in improper enforcement and create safety concerns. Please contact your local, authorized, Glacier Bay dealer to buy these parts at the same price.

Price and availability subject to change.

Service Class	Part Number	Description
	20163362	2700 Swim Step Rails w/4 (Backing Plates)
	20163356	2740/2770 Cockpit Drain Cover (14GA S/S)
	26500508	2740/2770 Stbd Wetbar Tiltout (Arctic White) (NEW PART) 3/22/2013
	26500508	2740/2770 Stbd Wetbar Tiltout (Arctic White) (NEW PART) 3/22/2013
	20156909	2770 Cabin Door w/ Frame (Arctic White)
	20156918	2770 Console Footrest Lid (Non-Skid Arctic White KSB)
	26500509	2770 E/C Cabinet (Arctic White) (NEW PART) 3/22/2013
	26500505	2770 E/C Counter Top (Hi-Macs Parma)
	20163514	2770 Entertainment Center Grabrail (36")
	20156937	2770 Head Cover (Seafoam Starboard) W/Cleat
	20330398	2770 Lifejacket Storage Canvas (Tan) - (Port/Stbd) (NEW PART) 3/22/2013

These parts should be installed by a certified Glacier Bay dealer. Installation by a non-authorized 3rd party may result in improper performance and create safety concerns. Please contact your local, authorized, Glacier Bay dealer to buy these parts at the same price.

Price and availability subject to change.

Service Class	Part Number	Description
	20156991	2770 L-Lounge Dinette Table (Hi-Macs Parma) (NEW PART) 4/8/2013
	20156972	2770 L-Lounge Storage Cabinet (Arctic White) (NEW PART) 3/22/2013
	20601071	2770 S/S Bow Rail
	26500506	2770 Wetbar Countertop (Hi-Mac Parma) (NEW PART) 3/1/2013
	20310290	2770 White Powder Coated 5-Piece Windshield w/ Manual Vent (NEW PART) 3/25/2013
	20160229	3" Cable Boot, Off White
	20160329	3" White Trim Ring (Chaffing Ring)
	20160231	3/8" Plastic Drain
	20150885	4" x 10" Almond Plastic Floor Register
	20156881	4" x 10" White Plastic Floor Register
	20163444	4.5" Cable Boot - Black

These parts should be installed by a certified Glacier Bay dealer. Installation by a non-authorized 3rd party may result in improper performance and create safety concerns. Please contact your local, authorized, Glacier Bay dealer to buy these parts at the same price.

Price and availability subject to change.

Service Class	Part Number	Description
	20163444	4.5" Cable Boot - Black
	20150233	7" Handrail w/ Studs, S/S Part
	20163550	8" Cutting Edge sleek pull up cleat
	20156968	Acrylic Small Hatch-GB White (2770/2740)
	20163361	Adjustable Windshield Brace (10 1/2"-12 1/2")
	20160470	Adjustable Windshield Brace (8 1/2"-10 1/2")
	20210267	Aluminum Cushioned Clamps (1")
	20210266	Aluminum Cushioned Clamps (3/4")
	20150333	Anchor Rode Special 8-Plaited Anchor Rope (2005)
	20150332	Anchor Safety Strap (2005)
	20150195	Anchor, Delta 14lb

These parts should be installed by a certified Glacier Bay dealer. Installation by a non-authorized 3rd party may result in improper performance and create safety concerns. Please contact your local, authorized, Glacier Bay dealer to buy these parts at the same price

Price and availability subject to change.

Service Class	Part Number	Description
	20151458	Armstrong 8" Watertight Access Plate - White (GB)
	20163486	ASI Bracket for Gas Shocks
	20163485	ASI S/S Flat Bracket for Gas Shocks w/10MM
	20150361	Cabin Cockpit Floor Base Cap
	20150359	Cabin Cockpit Floor Base, 5" (for Table)
	20150360	Cabin Cockpit Table Base
	20150353	Cabin Cockpit Table Post 27"
	26500476	Cabin Interior Flooring 2770 Teak/Holly (Matte Finish)
	20170217	Cabin Portlight w/ S/S Ring
	20160377	Chrome Vent (3" x 2.5")
	20140107	Clear Hose 3/8" (200'/RL)











These parts should be installed by a certified Glacier Bay dealer. Installation by a non-authorized 3rd party may result in improper enforcement and create safety concerns. Please contact your local, authorized, Glacier Bay dealer to buy these parts at the same price.

Price and availability subject to change.

Service Class	Part Number	Description
	20160227	Compass Plate 5 5/8"
	20430001	Draw Latch (Small Rubber 4.16")
	20160477	Draw Latch Keeper
	20156911	Drop-In Tub Cleat/Handle (2740/2770) (Arctic White)
	26500443	Faucet - Single Lever/Cold H2O (2740/2770)
	20161421	Flexible Rub Rail - White 250'
	26500498	Flush-Mount Transom Seat Cabinet (Port) (2770/2740) (Arctic White)
	26500499	Flush-Mount Transom Seat Cabinet (Starboard) (2770/2740) (Arctic White)
	20163466	Gas Shock 12" Ext. Length, 30lb, 316SS w/ Composite End
	20610391	GB 26/27 Transom Pre-Bent No Miter Port 304 (Arctic White Rubrail)
	20610392	GB 26/27 Transom Pre-Bent No Miter Stbd 304 (Arctic White Rubrail)

These parts should be installed by a certified Glacier Bay dealer. Installation by a non-authorized 3rd party may result in improper performance and create safety concerns. Please contact your local, authorized, Glacier Bay dealer to buy these parts at the same price

Price and availability subject to change.

Service Class	Part Number	Description
	20161444	GB Swim Step Bolts (3/8" x 5" SS HCS)
	20160275	GEM S/S Lift Handle Latch Lock 3"
	20156994	Glacier Bay 2700 Transom Door (Arctic White Acrylic) LOGO NOT INCLUDED
	20151104	Grill Mounts w/ legs (Magma Newport)
	20150317	Handrail 48" (Pair)
	20156928	Hatch Molded 11x15 Arctic White (Jim Black)
	20160703	Hinge 2" x 3" Anchor Lid Style
	20160688	Hinge UN96
	20160671	Hinge, SS Round Side 2 Pin
	20160363	Holder Magnetic Window 316SS 30 x 15 Strike
	20163504	IPS 4" Access Plate (Arctic White)

These parts should be installed by a certified Glacier Bay dealer. Installation by a non-authorized 3rd party may result in improper enforcement and create safety concerns. Please contact your local, authorized, Glacier Bay dealer to buy these parts at the same price.

Price and availability subject to change.

Service Class	Part Number	Description
	20163472	IPS 4" Access Plate (Dream White - World Cat)
	20163473	IPS 6" Access Plate (Dream White - World Cat)
	20163474	IPS 8" Access Plate (Dream White - World Cat)
	20156912	Large Access Hatch - 14x23 (Arctic White)
	**20163587	Latch Cam Special M10 X 1.5 Thd T316
	20156923	Leanbar Drink Holder Insert (Arctic White)
	20163459	Lewmar SZ-70 Flush Hatch (Smoked Acrylic)
	26500477	Lewmar SZ-70 Flush Hatch Ivory Trim Ring/Screen Kit
	20160465	Lid Lock Spacer 2"-Black
	20160687	Lift Pin, 2" (Swim Platform)
	20160243	Lifting Eye, Round

These parts should be installed by a certified Glacier Bay dealer. Installation by a non-authorized 3rd party may result in improper performance and create safety concerns. Please contact your local, authorized, Glacier Bay dealer to buy these parts at the same price.

Price and availability subject to change.

Service Class	Part Number	Description
	20160357	Magnetic Door Holder (Proud/Flush)
	20151103	Marine LP Grill (Magma Newport Gourmet Series)
	20161231	Medium Anchor Bow Roller SS Captive 3"
	26500510	Microwave Cabinet - Weathered Ash Matte Finish (2770) (NEW PART) 3/22/2013
	20151038	Pedestal Storage Clips
	20160579	Piano Hinge (2.5"W/050) - 16"
	20160580	Piano Hinge (2.5"W/050) - 19 1/2"
	20610390	Pre-Formed 304SS & Vinyl Bow Section (GB 2740 Arctic White)
	20156913	Pulpit Anchor Protection Plate (GB 2700's) (Arctic White)
	20163542	Push to Close Latch, Slide (Non-Magnet)
	20160344	Rigging Flange Hose Union (Black)

These parts should be installed by a certified Glacier Bay dealer. Installation by a non-authorized 3rd party may result in improper performance and create safety concerns. Please contact your local, authorized, Glacier Bay dealer to buy these parts at the same price.

Price and availability subject to change.

Service Class	Part Number	Description
	20140123	Rigging Hose-Black 2" (50'/RL)
	20150259	Rod Holder Grommet (3 3/8")
	20156914	Rod Rack (2740) (Arctic White)
	20163493	Rod Tip Grommets-Chaffing Rings
	20150252	Rub Rail Insert - Bendable Polished 304 S/S (16' EA)
	20156872	S/S 1-Step Short Cup Holder w/ Drain (92mm)
	20156871	S/S 2-Step Cup Holder w/ Drain (92mm)
	20163391	S/S 30" Rod Holder (Cast Head, Formed Tube w/ Drain)
	60233231	Safety Walk 12" x 60' Black (60FT/RL)
	20160044	Screen for Portlight
	20163546	Seat Slide & Swivel seat base, Springfield Marine







These parts should be installed by a certified Glacier Bay dealer. Installation by a non-authorized 3rd party may result in improper performance and create safety concerns. Please contact your local, authorized, Glacier Bay dealer to buy these parts at the same price.

Price and availability subject to change.

Service Class	Part Number	Description
	20170254	Stainless FIAM Horn
	20160236	Thru Hull Plastic 90 1 1/2"
	20160237	Thru Hull Plastic 90 3/4"
	20150008	Toilet Paper Holder (Metal / Base Mount)
	20610386	Transom Molding (Arctic White) 12' EA Thinner / No Holes
	20161420	White Rubrail Insert (250FT Spools EA)
Hardware- Hull		
	20160242	8" Cleat
	20800321	Aluminum 8"x8"x1/4" Bow Eye Plate
	20161503	Bow Eye 304SS 1/2" x 4 3/4" GLO, SS Nuts
	20163363	Brass Motorwell Drain (1"x 4")
	20163500	Challenger 3-Step Telescoping Transom Ladder (304SS) (LDH-3-BB)











These parts should be installed by a certified Glacier Bay dealer. Installation by a non-authorized 3rd party may result in improper performance and create safety concerns. Please contact your local, authorized, Glacier Bay dealer to buy these parts at the same price.

Price and availability subject to change.

Service Class	Part Number	Description
	20150225	Drain Plug (Garboard)
	W7013398	Mounting Plate for 120VAC AC Pump
	20610270	Rigging Flange (2") Black
	20160640	Transom End Cap, Nylon, Black
	20160383	Transom Motor Plate (Lower)
	20161423	Transom Motor Plate (Upper) - No Branding
	90441603	Yamaha Premier II Control Cable (24')
	90441603	Yamaha Premier II Control Cable (24')
Plumbing		
	20160040	1 1/2 3 Way Tee Fitting
	20160537	1 1/2" Drain w/ Screen
	20160512	1 1/2" Waste Pump Out

These parts should be installed by a certified Glacier Bay dealer. Installation by a non-authorized 3rd party may result in improper performance and create safety concerns. Please contact your local, authorized, Glacier Bay dealer to buy these parts at the same price

Price and availability subject to change.

Service Class	Part Number	Description
	20160510	1 1/2" Water Fill
	20161461	1" MPT X 1" HB 90 PVC Elbow
	20160087	1/2 PT X 3/4 HB "L", PVC Elbow 1234
	20160093	1/2 PT X 3/8 HB "L", EL1238
	20740253	120VAC Pump for AC
	20160469	250DC/2740 Wiper Spacer Block
	20160466	3 Way Reducing Tee (1 1/8" x 3/4" x 1 1/8")
	20160039	3/4 x 3/4 HB Tee
	20160127	3/4" Brass Intake w/ Nut Hi-Speed Water Pick up Bronze
	20160127	3/4" Brass Intake w/ Nut Hi-Speed Water Pick up Bronze
	20160542	3/8" HB Tee











These parts should be installed by a certified Glacier Bay dealer. Installation by a non-authorized 3rd party may result in improper performance and create safety concerns. Please contact your local, authorized, Glacier Bay dealer to buy these parts at the same price.

Price and availability subject to change.

Service Class	Part Number	Description
	20160335	5/8" Hose Barb x 3/4" Hose Barb
	20160547	Automatic Float Switch Mounting Brkt
	20160560	Ball Valve, Brass, 3/4"
	20160560	Ball Valve, Brass, 3/4"
	20163379	Barbed 3/4" 90 Degree Aerator Head-Livewell Inlet w/ Shutoff Black
	20140100	Bilge Hose 1 1/2" (100'/RL)
	20140099	Bilge Hose 1 1/8" (100'/RL)
	20140098	Bilge Hose 3/4" (100'/RL)
	20160339	Drain, Head 320EC
	20160094	Elbow, Faucet 3/4 HB X 1/2 FPT
	20820440	Headhunter Inlet Strainer (3/4")











These parts should be installed by a certified Glacier Bay dealer. Installation by a non-authorized 3rd party may result in improper performance and create safety concerns. Please contact your local, authorized, Glacier Bay dealer to buy these parts at the same price.

Price and availability subject to change.

Service Class	Part Number	Description
	20820440	Headhunter Inlet Strainer (3/4")
	20161412	Hose Barb Adapter (3/4" MPT x 1 1/8" HB)
	W7013314	Impeller Kit for Shurflo Macerator Pump
	20150381	Jabsco Elongated Toilet Electric CE 12V
	20740291	Johnson Multi Port Shower Sump (w/ Ultima Auto Pump)
	20740248	Macerator Pump w/ Deutsch Plug
	20160536	Nylon Elbow (3/4" MPT x 1" HB)
	20160267	Nylon Elbow 3/4" Male PT x 3/4" HB
	20160267	Nylon Elbow 3/4" Male PT x 3/4" HB
	20161489	Nylon Female Adapter 1/2" FPT x 3/4" HB
	20160142	Plastic Elbow (3/4") 90 DEG

These parts should be installed by a certified Glacier Bay dealer. Installation by a non-authorized 3rd party may result in improper performance and create safety concerns. Please contact your local, authorized, Glacier Bay dealer to buy these parts at the same price.

Price and availability subject to change.

Service Class	Part Number	Description
	20740299	Rule-A-Matic Float Switch w/ Deutsch Plug
	20740250	Rule-Mate Bilge Pump w/ Deutsch (500 GPH)
	20740298	Rule-Non Automatic Bilge pump w/ Deutsch (1500 GPH)
	20140128	Sanitation Hose 1" (100'/RL)
	20140127	Sanitation Hose 1.5" (100'/RL)
	26500302	Scandvik Euro Sprayer
	26500275	Scandvik Euro Sprayer Bracket
	20163570	Screw-In S/S Water Inlet (2015MY)
	20740302	Shurflo 800 Bait Sentry w/ Deutsch plug
	20740303	ShurFlo Pro Blaster 2 Water Pump
	60233362	Sika White #292i-W High Strength Adhesive Sealer

These parts should be installed by a certified Glacier Bay dealer. Installation by a non-authorized 3rd party may result in improper performance and create safety concerns. Please contact your local, authorized, Glacier Bay dealer to buy these parts at the same price

Price and availability subject to change.

Service Class	Part Number	Description
	20160331	Stainless Sink Drain
	20160332	Stainless Sink Drain Reducer
	20820852	Strainer Mounting Bracket
	20820852	Strainer Mounting Bracket
	20161462	Swivel Nut Water Strainer for Washdown Pumps
	20160355	Thru Hull Bronze 3/4"
	20160218	Thru Hull Plastic 1 1/8"
	20160219	Thru Hull Plastic 90 1 1/8"
	20163451	Thru-Hull, Resin 90° w/SS Cover, 1"
	20163452	Thru-Hull, Resin 90° w/SS Cover, 1-1/8"
	20163450	Thru-Hull, Resin 90° w/SS Cover, 3/4"

These parts should be installed by a certified Glacier Bay dealer. Installation by a non-authorized 3rd party may result in improper performance and create safety concerns. Please contact your local, authorized, Glacier Bay dealer to buy these parts at the same price.

Price and availability subject to change.

Service Class	Part Number	Description
	20163450	Thru-Hull, Resin 90° w/SS Cover, 3/4"
	20163456	Thru-Hull, Resin w/SS Cover, 1-1/2"
	20163455	Thru-Hull, Resin w/SS Cover, 1-1/8" - 1-1/4"
	20163457	Thru-Transom Scupper, Resin, w/ SS Cover, 1-1/2" (4-3/8")
	20160220	Vinyl Push Plug (1-1/2") Black
	20170878	Washer Jet (SS) - Bulkhead Mount
	20220037	Waste Tank 15 Gal
	20220041	Water Tank 20 Gal
	20163583	Whale Twist Deck Shower Flat Base (Cold Only)
	20161447	Wingnut Adapter, 90 Nylon 3/4 HB X 1/2 NPT / for Washdown Pump
	20160192	Wingnut Adapter, Straight Nylon 3/4 HB X 1/2 NPT / for Washdown Pump

These parts should be installed by a certified Glacier Bay dealer. Installation by a non-authorized 3rd party may result in improper performance and create safety concerns. Please contact your local, authorized, Glacier Bay dealer to buy these parts at the same price.

Price and availability subject to change.

Service Class	Part Number	Description
	20173467	Wiper Arm (19"-24")
	20170912	Wiper Controls Intermittent Switch

Service Kits

W7013479	Hatch Arm
W7013449	Screen Only for Lewmar SZ-70 Flush Hatch

Steering



W7010050 50amp Fuse Assembly (for Power Steering)



20160624 Black 5 1/2" Dia Motorwell Boot



20161419 Bracket for Clevis Kit (Connector to Engine Mount)



20161418 Bracket for Clevis Kit (Connector to Steering Rod)



20160604 Clevis Kit (Link Arm to Engine)













20151229 Doel-Fin Black Outboard/Out



20180965 Gem 13-1/2" 3-Spoke S/S Steering Wheel w/ Ball Bearing Knob (w/ 1501-- 5/8" wheel nut)

These parts should be installed by a certified Glacier Bay dealer. Installation by a non-authorized 3rd party may result in improper performance and create safety concerns. Please contact your local, authorized, Glacier Bay dealer to buy these parts at the same price.

Price and availability subject to change.

Service Class	Part Number	Description
	20180022	Hydraulic Tilt Helm Sea Star HH6541
	20160643	Link Arm 13 5/8" (2600 Series).
	20161407	Modified 3" Bolt for Clevis Steering Kit
	20160697	Mounting Brkt - Steering Cylinder (GB 22/26)
	20160603	Sea Star CAT Cylinder HC5343 (GB 22/26)
	20180971	Seastar Power Assist Unit (25' Cable)
	20161410	Spacer for Clevis Steering Kit
	90410371	Suzuki LH Prop (3 x 16 x 20)
	90410370	Suzuki RH Prop (3 x 16 x 20)
	20180094	Teleflex Power Steering Diode (Keyswitch)
Upholstery		
	20291003	2770 Cabin Pillow (Tide Ale)

These parts should be installed by a certified Glacier Bay dealer. Installation by a non-authorized 3rd party may result in improper performance and create safety concerns. Please contact your local, authorized, Glacier Bay dealer to buy these parts at the same price.

Price and availability subject to change.

Service Class	Part Number	Description
	20291004	2770 Cabin Pillow (Titanium Pinecone)
	20291005	2770 Privacy Curtain (G3651 Dupioni 03 Taupe)
	20291025	Bolster Clip 1/4" Offset (16GA 316SS)
	20290970	Cushion - Bow Seat (2770) (NEW PART) 3/22/2013
	20290971	Cushion Helm Seat w/ Bolsters/Armrest 24"W (GB 2700's) (NEW PART) 3/22/2013
	20290972	Cushion Lounge Backrest - Center (2770) (NEW PART) 3/22/2013
	20290979	Cushion Lounge Backrest - OB Lounge (2770) (NEW PART) 3/22/2013
	20290973	Cushion Lounge Seat - Center (2770) (NEW PART) 3/22/2013
	20290974	Cushion Lounge Seat - OB Lounge (2770) (NEW PART) 3/22/2013
	20290978	Cushion Queen Berth - 2770 Aft Cushion, Karma Karmic Cashmere (NEW PART) 3/22/2013
	20290977	Cushion Queen Berth - 2770 Fwd Cushion, Karma Karmic Cashmere (NEW PART) 3/22/2013

These parts should be installed by a certified Glacier Bay dealer. Installation by a non-authorized 3rd party may result in improper performance and create safety concerns. Please contact your local, authorized, Glacier Bay dealer to buy these parts at the same price.

Price and availability subject to change.

Service Class	Part Number	Description
	20290940	Cushion Queen Berth - 2770 Stbd, Karma Karmic Cashmere (NEW PART) 2/28/2013
	20290975	Cushion Straight Coaming - Port (2770) (NEW PART) 3/22/2013
	20290976	Cushion Straight Coaming - Stbd (2770) (NEW PART) 3/22/2013
	20290968	Cushion Transom Backrest - Port/Stbd (2740/2770)
	20290969	Cushion Transom Seat - Port/Stbd (2740/2770)
	65040082	Screw In Studs 3/8"

These parts should be installed by a certified Glacier Bay dealer. Installation by a non-authorized 3rd party may result in improper enforcement and create safety concerns. Please contact your local, authorized, Glacier Bay dealer to buy these parts at the same price.

Price and availability subject to change.



WORLDCAT

1090 West Saint James Street, Tarboro, NC 27886 866.485.8899

WORLD**CAT**.COM